



Brussels, 18.6.2015
SWD(2015) 118 final

COMMISSION STAFF WORKING DOCUMENT

Towards a new Union Framework for collection, management and use of data in the fisheries sector and support for scientific advice regarding the Common Fisheries Policy

Accompanying the document

**Proposal for a
Regulation of the European Parliament and of the Council**

**concerning the establishment of a Union framework for the collection, management and the use of data in the fisheries sector and support for the scientific advice regarding the Common Fisheries Policy
(recast)**

{COM(2015) 294 final}

COMMISSION STAFF WORKING DOCUMENT

Towards a new Union Framework for collection, management and use of data in the fisheries sector and support for scientific advice regarding the Common Fisheries Policy

Accompanying the document

**Proposal for a
Regulation of the European Parliament and of the Council**

**concerning the establishment of a Union framework for the collection, management and the use of data in the fisheries sector and support for the scientific advice regarding the
Common Fisheries Policy
(recast)**

Contents

0. List of acronyms.....	5
1. INTRODUCTION.....	6
1.1. Background.....	6
1.2. What data do Member States collect, and what for?.....	8
1.3. How do Member States collect data?.....	11
1.4. Who has access to data?.....	12
2. PREPARATORY WORK AND CONSULTATIONS FOR THE AMENDMENT OF THE DCF.....	13
2.1. Consultation of interested parties.....	13
2.2. Studies.....	15
2.2.1. Impact Assessment (IA) carried out in the framework of the CFP reform.....	15
2.2.2. Interim evaluation on Council Regulation 861/2006.....	15
2.2.3. Ex-post evaluation of the Data Collection Framework.....	16
2.2.4. Assessment of implementation of the DCF through field visits in Member States ...	17
2.2.5. STECF evaluations of Member States' Annual Reports.....	19
2.2.6. Interim evaluation of the European Marine Observation and Data Network.....	19
2.2.7. Feasibility study on data storage and transmission.....	19
3. STRENGTHS AND WEAKNESSES OF THE CURRENT LEGAL FRAMEWORK.....	21
4. THE BROADER CONTEXT.....	22
5. PROPOSED AMENDMENTS TO THE CURRENT LEGISLATION.....	26
5.1. The future data collection process.....	26
5.1.1. End-user oriented data collection.....	26
5.1.2. Strengthening regional and EU coordination.....	30
5.2. The scope of the future DCF – what data should Member States collect and how to avoid overlaps.....	35
5.2.1. Data on marine biological resources.....	35
5.2.2. Data on fishing activity.....	44
5.2.3. Data on the aquaculture and processing sectors.....	47
5.3. How data should be collected.....	52
5.4. Ensuring adequate quality of the data.....	55
5.5. Improving availability of data.....	57
5.6. Data collection in external waters.....	65
5.7. Programming and reporting.....	66
6. LEGAL ARCHITECTURE.....	69

7.	ANNEXES	70
1.	The revised DCF Regulation.....	85
2.	The EU Multiannual Programme	85
3.	Operational Programmes.....	85
4.	National work plans	86
5.	Regional work plans.....	86

0. LIST OF ACRONYMS

CCTV Closed-circuit television
CECAF Committee for the Eastern Central Atlantic Fisheries
CFP Common Fisheries Policy
DCF Data Collection Framework
DCR Data Collection Regulation
EFARO European Fisheries and Aquaculture Research Organisations
EMFF European Maritime and Fisheries Fund
EUCG European Union Coordination Group
EU MAP European Union Multiannual Programme
ICES International Council for Exploration of the Sea
GFCM General Fisheries Commission for the Mediterranean
JRC Joint Research Centre of the European Commission
MEDIAS Mediterranean Acoustic Survey
MEDITS International Bottom Trawl Survey in the Mediterranean
MSFD Marine Strategy Framework Directive
NP National Programme
RCG Regional Coordination Group
RCM Regional Coordination Meeting
RFB Regional Fisheries Body
RFMO Regional Fisheries Management Organization
SFPA Sustainable Fisheries Partnership Agreement
STECF Scientific Technical and Economic Committee for Fisheries
WECAFC Western Central Atlantic Fishery Commission

1. INTRODUCTION

This document accompanies the COM(2015)294final *proposal for a Regulation of the European Parliament and of the Council concerning the establishment of a Union framework for the collection, management and use of data in the fisheries sector and support for scientific advice regarding the Common Fisheries Policy (recast)* explaining the rationale behind the modifications and simplification and the technical details necessary to understand those modifications.

This document describes the current data collection system and informs about the need to maintain most of the elements of the current legislation and the need, however, to amend and improve some aspects of it in line with the wish of the co-legislators and the recommendations from the consultations and evaluations. It describes the preparatory work consisting of the publication of a roadmap¹ discussing several legislative options, further consultations and explains the options choices for improvement and simplification of the system, including the modification of the legal setup.

1.1. Background

Data collection is part of the core functioning of the Common Fisheries Policy (CFP). Reliable and complete data are central to well-functioning fisheries management as they provide the basic information for scientific advice and for the monitoring of the European fisheries sector. For this reason, an EU framework for the collection and management of fisheries data was established in 2000 (referred to as the data Collection Regulation, DCR)², and then reformed in 2008 resulting in the Data Collection Framework (DCF). The DCF establishes a harmonized set of EU rules governing the collection of biological, environmental, technical, and socio-economic data on the fishing sector, the aquaculture and processing sector striving for better availability of data to the scientists resulting in improved advice to data users including the Commission.

The DCR and subsequent DCF did not necessarily imply an increase in the number of the data previously collected by Member States. What it did was to provide the general framework and the quality controls necessary to ensure the homogeneity of the data sets and a common collection system³.

¹ http://ec.europa.eu/smart-regulation/impact/planned_ia/roadmaps_2014_en.htm#MARE

² **Council Regulation (EC) No 1543/2000** of 29 June 2000 establishing a Community framework for the collection and management of the data needed to conduct the common fisheries policy

³ European Parliament report (Policy Department B, Structural and Cohesion Policies), 2008: New Opportunities Offered by the Data Collection Regulation in the Fields of Biology and Economy (Council regulation N° 199/2008/EC) [http://www.europarl.europa.eu/RegData/etudes/note/join/2008/408935/IPOL-PECH_NT\(2008\)408935_EN.pdf](http://www.europarl.europa.eu/RegData/etudes/note/join/2008/408935/IPOL-PECH_NT(2008)408935_EN.pdf)

The legal set-up for the DCF can be summarised as follows (**Figure 1**).

Figure 1: Legal set up for the Data Collection Framework

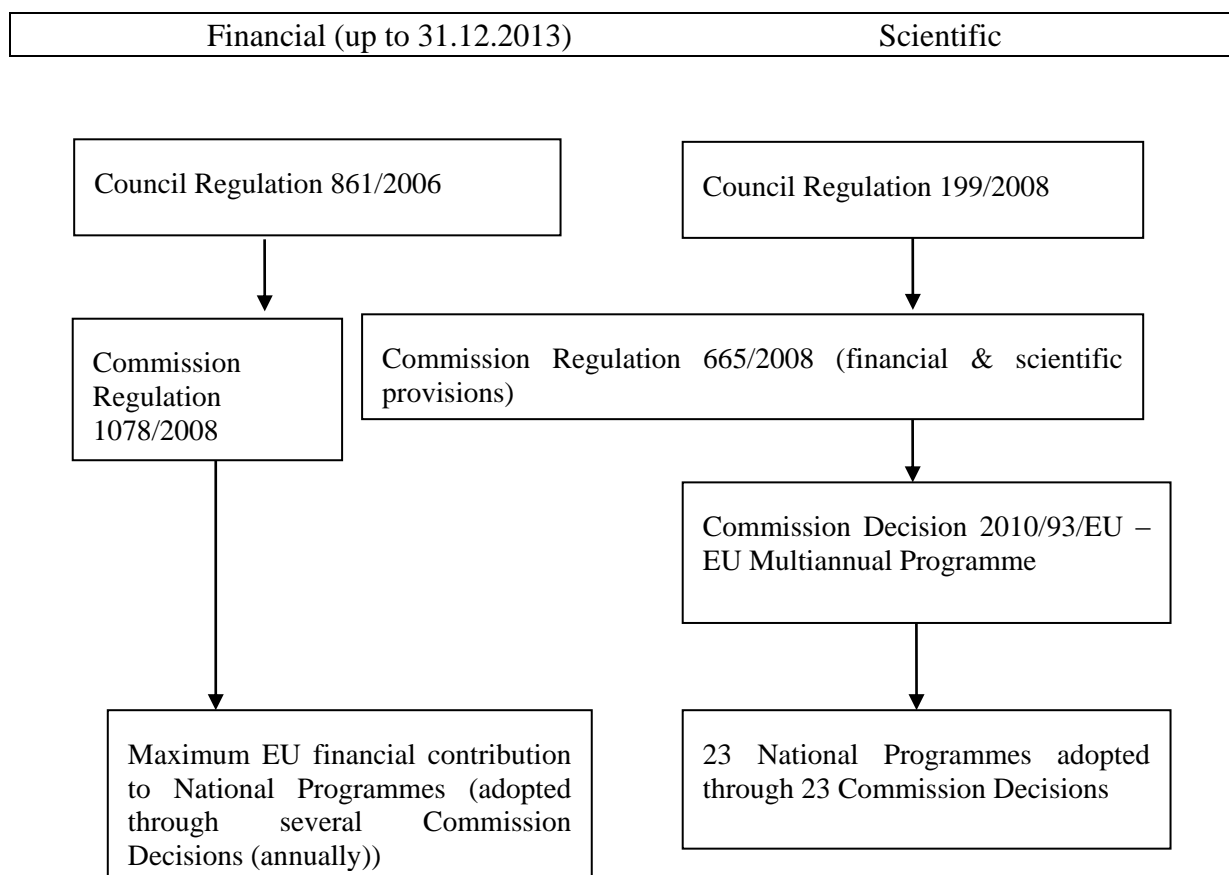

The DCF consists of the following legal instruments:

- **Council Regulation (EC) No 199/2008** of 25 February 2008⁴ concerning the establishment of a Community framework for the collection, management and use of data in the fisheries sector and support for scientific advice regarding the Common Fisheries Policy framework for fisheries
- **Commission Regulation (EC) No 665/2008** of 14 July 2008⁵ laying down detailed rules for the application of Council Regulation (EC) No 199/2008 concerning the establishment of a Community framework for the collection, management and use of data in the fisheries sector and support for scientific advice regarding the Common Fisheries Policy
- **Commission Decision 2010/93/EU** of 18 December 2009 adopting a multiannual Community programme (EU MAP) for the collection, management and use of data in the fisheries sector for the period 2011-2013 (C(2009) 10121). The application of

⁴ OJ L60, 5.3.2008, p.1

⁵ OJ L186, 15.7.2008, p.3

this decision has been extended by Commission Implementing Decision of 13.8.2013 to the period 2014-2016 (C(2013)5243⁶).

Beyond this legal framework, the main tools to implement the DCF are:

- **Programming:** Member States **multi-annual programmes** (referred to as National Programmes, or NPs). These are set for three years (currently 2014-2016) and contain the Member States' obligations to collect and provide data relevant to their region/fisheries/sectors pursuant to the EU Multiannual Programme. NPs are analysed by the EU's Scientific Technical and Economic Committee for Fisheries (STECF)⁷ and are adopted by the Commission. NPs can be modified if requested by a Member State and after evaluation of the proposed changes by the STECF.
- **Monitoring:** Member States are required to submit **Annual Reports** on the implementation of their NPs. These present an overview of the data that were collected in a given year (number of samples taken, quality of data collected, percentage of sector surveyed etc). The Commission assesses the implementation of National Programmes on the basis of 1) the STECF's evaluation of the Annual Reports and 2) a consultation of appropriate Regional Fisheries Management Organizations (RFMOs) and international scientific bodies such as ICES regarding the DCF data they received from Member States.
- **Financial support:** until end of 2013, Member States' data collection activities under their DCF National Programmes were eligible for 50% EU co-financing (Regulation (EC) No 861/2006⁸). As of 2014, such activities are eligible for EU co-financed under the European Maritime and Fisheries Fund (EMFF)⁹, which is the financial pillar of the new CFP.

The DCF is applied in the 23 coastal Member States¹⁰ but not in land-locked Member States.

1.2. What data do Member States collect, and what for?

The EU MAP further details the requirements of the DCF for Member States to collect data. The EU MAP essentially contains data collection requirements relating to the following: the categories of data covered by the EU MAP (i.e. species and variables, such as age, length, weight etc), the sectors they cover and the methods to be used to collect these data (see Table

⁶ **Commission implementing Decision C(2013)5243** of 13.8.2013 extending the multiannual Union programme for the collection, management and use of data in the fisheries sector for the period 2011-2013 to the period 2014-2016

⁷ The **STECF** may be consulted by the Commission on all problems connected with the provisions governing access to zones and resources of EU fisheries and the regulation of fisheries activities. The Members of the STECF are nominated by the Commission from highly qualified scientific experts having competence in these fields.

⁸ **Council Regulation (EC) No 861/2006** of 22 May 2006 establishing Community financial measures for the implementation of the common fisheries policy and in the area of the Law of the Sea OJ L160, 14.6.2006, p.1 and **Commission Regulation (EC) No 1078/2008** of 3 November 2008 laying down detailed rules for the implementation of Council Regulation (EC) No 861/2006 as regards the expenditure incurred by Member States for the collection and management of the basic fisheries data OJ L295, 4.11.2008, p.24

⁹ **Regulation (EU) No 508/2014 of the European Parliament and of the Council** of 15 May 2014 on the European Maritime and Fisheries Fund and repealing Council Regulations (EC) No 2328/2003, (EC) No 861/2006, (EC) No 1198/2006 and (EC) No 791/2007 and Regulation (EU) No 1255/2011 of the European Parliament and of the Council (OJ L 149, 20.5.2014, p. 1.

¹⁰ Belgium, Bulgaria, Croatia, Cyprus, Denmark, Estonia, Finland, France, Germany, Greece, Ireland, Italy, Latvia, Lithuania, Malta, Netherlands, Poland, Portugal, Romania, Slovenia, Spain, Sweden and the United Kingdom.

1). The EU MAP contains not only lists of data that should be collected, but also detailed provisions on the methodology to be followed to collect them, the precision levels that should be achieved and the frequency with which the data should be collected.

Table 1: Overview of the data covered by the EU Multiannual Programme

	DCF							
	Fishing sector					Aquaculture & Processing Industry		Marine Ecosystem
	Socio-economic data	Biological data		Fishing activity data	Research surveys at sea	Aquaculture: Socio-economic	Processing: Socio-economic	
		Metier-related	Stock-related					
Appendices of EU MAP	<u>II</u> , <u>III</u> , <u>VI</u> , <u>VIII</u>	<u>I</u> , <u>II</u> , <u>IV</u> , <u>VII</u>	<u>VII</u>	<u>V</u> , <u>VIII</u>	<u>IX</u>	<u>X</u> , <u>XI</u>	<u>XII</u>	
Variables (examples)	Enterprises Employment Income Expenditure Capital value Fuel costs Repair & maintenance Investments Subsidies	Discards Effort Growth Landings Maturity Sex ratio		Capacity Effort Landings	Several at-sea research surveys (demersal and pelagic)	Income Personal costs Energy costs Raw Material costs Other Operational costs Capital costs Extraordinary costs Capital Value Net Investment Debt Employment Enterprises		

Member States must collect and make these data available to data users to support scientific analysis for the following purposes:

- (a) as a basis for advice to fisheries management, including to Regional Advisory Councils;
- (b) in the interest of public debate and stakeholder participation in policy development;
- (c) for scientific publication.

Concretely, DCF data serve a range of purposes, aiming to enable the assessment of:

- a) the state of **exploited marine biological resources** i.e. fish and certain invertebrates. This is done through scientific assessment of the state of these stocks and the impact of fisheries on them;
- b) the impact of fishing activities on **other parts of the marine eco-systems** (beyond the fish and invertebrates targeted by fisheries);

c) the **socio-economic performance of the fisheries, aquaculture and processing** sectors and the social and economic impacts of policy measures.

The way in which DCF data are used is described in **Textbox 1**.

Textbox 1 – How are DCF data used

1. For the assessment of the socio-economic situation of fisheries: the data collected under the DCF are used to:

- Carry out impact assessments of fisheries policy measures (e.g. on the CFP reform, on deep sea stocks, cost-benefit assessment of EU Fisheries Partnership Agreements, etc...) and analysis of conservation measures (evaluation of all management plans, bio-economic modelling to assess fisheries policy options, negotiations on Atlantic mackerel with non-EU countries, etc..).
- Fulfil the international obligations of the EU: DCF socio-economic data are used by other international institutions dealing with fisheries policies e.g. the FAO or the OECD.
- Prepare and monitor the impact of EU funding programmes: in the preparation of the EMFF operational programmes, DCF data are used to support the analysis of structural policies in fleets, aquaculture and fish processing sectors (i.e. common indicators in the EMFF, evaluation of EU-funded programmes in fisheries, etc)
- Calculate overcapacity indicators that are necessary for Member States and the Commission to conduct an analysis of the balance of EU fleets as required by the CFP Regulation.
- Provide the basic input in fisheries research projects: socio-economic DCF is the main source in research (FP 7 projects) and recent scientific literature dealing with management of EU fisheries.
- Prepare and monitor EU policy planning and programming: DCF data are the basis for the indicators and results in the Commission (DG MARE) annual management plans.
- Monitoring of the EU fisheries policy by stakeholders: many studies on fisheries policy by the European Parliament, NGOs, academics, etc and general public publications are based on DCF data.

2. For the purpose of scientific advice on exploited fisheries: The process of scientific advice provision in fisheries is organized in three consecutive steps:

1. Data collection by Member States (for example quantity of hake caught in a given area, as well as biological characteristics such as weight, ages etc.)
2. Transmission of raw or processed data to data users (i.e. scientists)
3. Scientific advice to Commission; the Commission relies on different scientific bodies to provide it with scientific advice, such as the Scientific, Technical and Economic Committee for Fisheries (STECF), the International Council for the Exploration of the Sea (ICES) and the scientific committees of RFMOs.

Decisions on fisheries management are then based on such scientific advice (for example setting annual total allowable catches (TACs) at EU level and corresponding national quotas), as illustrated below:

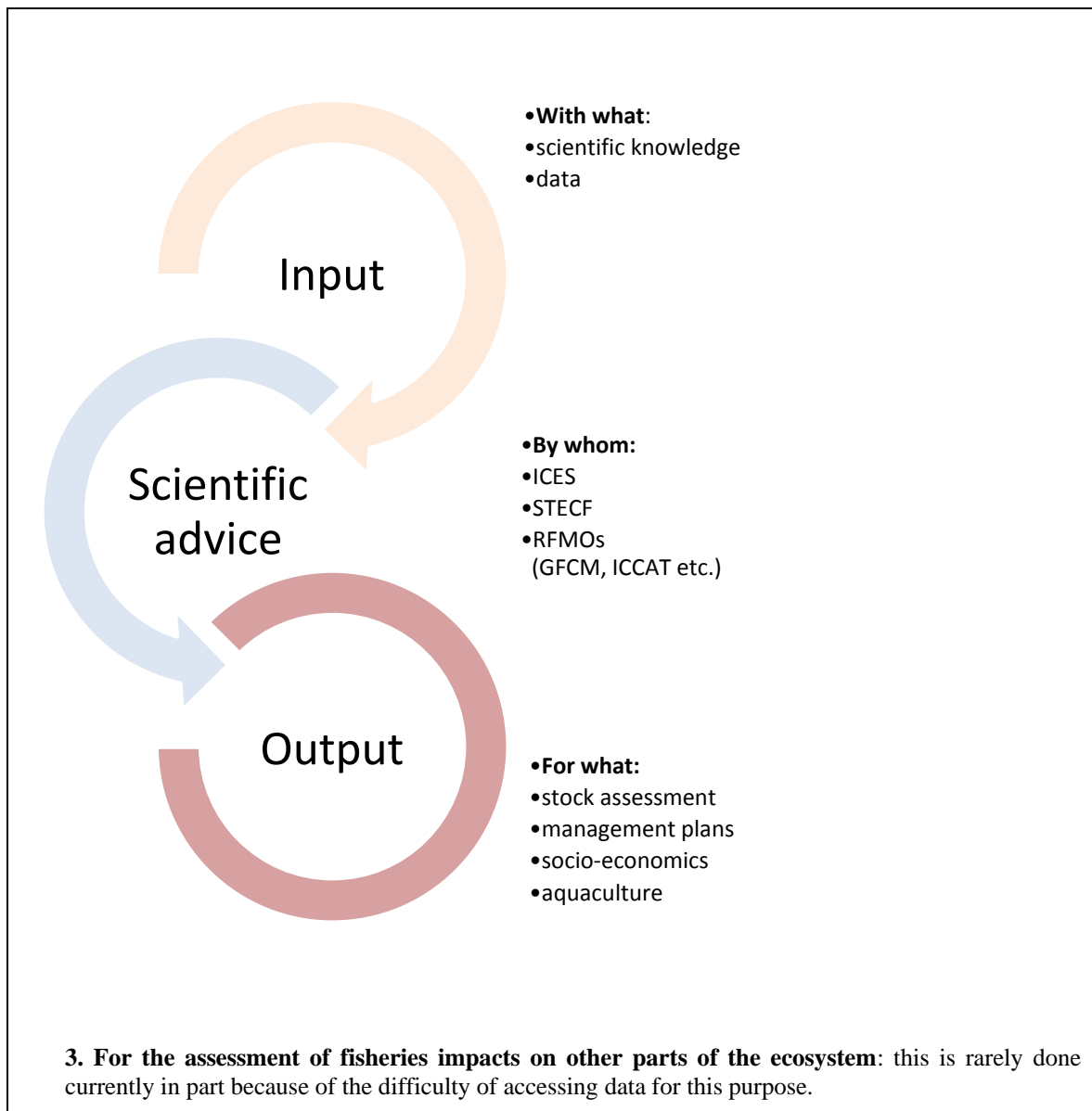

1.3. How do Member States collect data?

In each Member State, DCF data are collected from various sources and the different categories of data covered by the DCF are collected in different ways.

Biological data on fish stocks are collected by Member States' scientific institutes through both fisheries dependent and independent surveys. More specifically:

- **Fisheries dependent data** are obtained through sampling of catches that are either sampled at sea through scientific observers on commercial vessels, or by scientists in harbours when the fish are landed. Scientists collect data on things like numbers, length, total weight, sex, fecundity of a part of the fish caught by the fishermen on board. Such surveys are based on representative sampling i.e. not all fishing trips are covered and not all landed products are sampled.
- **Fisheries independent data** are obtained through research surveys at sea that are carried out by a team of scientists and technicians on board a dedicated research vessel, carrying out standardized sampling (they can decide where to take the boat and where to carry out hauls). Scientists collect similar data to those collected in fisheries-

dependent surveys, but research surveys at sea allow for greater control of the experimental design and provides data used to complement the fisheries-dependent data in stock assessments.

Data on **fishing activity** (capacity, effort, catches and landings) are collected by Member States' competent authorities using primarily the tools established under the Control Regulation¹¹ (see Table 6 for further details on relevant EU legislation for such data). They are referred to as "transversal data" under the DCF and come from VMS, logbooks, landings authorizations and sales notes. These data are provided to and used by scientific institutes as they are an integral part (together with biological data collected under the DCF) of the estimates that constitute stock assessments as well as being essential for science based management measures and evaluation of management objectives. For example, capacity, effort and landings data are necessary to calculate the catch per unit effort, to enable scientists to identify the top métiers to sample for biological data, as well as to disaggregate the fleet economic data so they can be combined with biological data.

Social and economic data concern not only fisheries but also aquaculture and processing industries. They are collected by Member States' scientific or statistical institutes, or national governmental departments, either through questionnaires and/or phone interviews, and also by using data from company accounts (e.g. on employees, profits etc) that can be obtained via the national statistical office.

1.4. Who has access to data?

The DCF Regulation distinguishes between several categories of data:

- 'primary data' means data associated with individual vessels, natural or legal persons or individual samples;
- 'meta data' means data giving qualitative and quantitative information on the collected primary data;
- 'detailed data' means data based on primary data in a form which does not allow natural persons or legal entities to be identified directly or indirectly;
- 'aggregated data' means the output resulting from summarising the primary or detailed data for specific analytic purposes;

Primary data collected under the DCF are the property of the Member State who collected them. These primary data remain at the national level, and are stored in national databases (generally several in each Member State) Member States are required to ensure that the data collected under the DCF are safely stored in these national databases and to take all necessary measures to ensure that primary data are treated as confidential. They must also take all necessary technical measures to protect such data against unauthorised consultation (Article 13).

Member States must process primary data into detailed and aggregated data (Article 17), in order to make them available to data users. Users of DCF data are defined in the DCF Regulation (as 'End-users') as follows: *bodies with a research or management interest in the scientific analysis of data in the fisheries sector*. This includes, for examples, RFMOs such as the GFCM or international scientific bodies such as ICES.

¹¹ **Council regulation (EC) No 1224/2009** of 20 November 2009 establishing a Community control system for ensuring compliance with the rules of the common fisheries policy

Regarding the use of these data, Member States are required to ensure that relevant detailed and aggregated **data are sent on a regular basis** to the appropriate RFMOs to which the EU is a contracting party or observer and to relevant international scientific bodies in accordance with the international obligations of the EU and the Member States (Article 20).

If a **specific request for data** (a so-called 'data call') is made by an end-user for the purpose of supporting scientific analysis, then Member States should also provide them with detailed and aggregated data (Article 18). Depending on the purpose that the data will be used for, Member States have different deadlines to make the data available to the end-users (Article 20):

- (a) as a basis for advice to fisheries management, including to Regional Advisory Councils (within one month of receiving the request for data);
- (b) in the interest of public debate and stakeholder participation in policy development (within two months of receiving the request for data);
- (c) for scientific publication (within two months of receiving the request for data but under certain conditions data may be withheld for three years following the date of collection of the data)..

However, Member States must ensure that personal data are protected and may therefore refuse to transmit the relevant detailed and aggregated data to end-users if there is a risk of natural persons and/or legal entities being identified, in which case the Member State may propose alternative means to meet the needs of the end-user which ensure anonymity (Article 20).

2. PREPARATORY WORK AND CONSULTATIONS FOR THE AMENDMENT OF THE DCF

In order to identify the issues that needed to be improved in the current DCF Regulation, and how best to do this, extensive consultation of stakeholders and many studies were carried out. The proposed changes to the DCF Regulation are based on the outcomes of these consultations and studies, as well as existing knowledge on the policy.

2.1. Consultation of interested parties

Extensive consultations on the revision of the DCF have taken place, in line with Commission practice. As the topic of fisheries data collection is a very technical one, target groups of practitioners and policy makers were principally consulted, and several methods of consultation were used.

The consulted parties included the Council and European Parliament, Member States, the scientific community, DCF Regional Coordination Meetings, data users such as the International Council for Exploration of the Sea (ICES), the General Fisheries Commission for the Mediterranean (GFCM), other Regional Fisheries Management Organizations (RFMOs), Non-governmental organizations (NGOs) and Advisory Groups (AC, formerly RACs), national research organisations through their network EFARO.

Specifically, since 2011, experts from the Scientific, Technical and Economic Committee for Fisheries (STECF) have been consulted in eight Expert Working Groups (EWG). Ten Regional Coordination Meetings for scientists and data users and four National

Correspondents¹² meetings were organised to provide advice on preparatory documents concerning future rules on data collection. Members of the European Parliaments were invited to comment twice and NGOs three times since 2011. Advisory Councils, RFMOs and EFARO were consulted once.

Consultations took place mainly through expert meetings in the context of the Scientific, Technical and Economic Committee for Fisheries (STECF), written consultations (Member States, key data users including ICES and GFCM), and a questionnaire in the context of an ex-post evaluation.

To conclude this series of consultations, a stakeholder workshop was held in Brussels on 16 January 2014¹³ focussing on the key topics for the revision. Participants included: Regional Fisheries Management Organizations (RFMOs), including the General Fisheries Commission for the Mediterranean (GFCM), Advisory Councils (ACs), the International Council for Exploration of the Seas (ICES), the European Fisheries and Aquaculture Research Organisation (EFARO), NGOs, Member States, Commission services (MARE, JRC, ESTAT, ENV, RTD). The workshop revealed that there is general agreement on : (1) the need for a limited expansion of the scope of the DCF to adjust to the new CFP (in particular the ecosystem approach), (2) how to improve data quality, (3) the need and means to simplify and rationalize (e.g. through streamlining EU legislation) (4) the importance of improved availability of data (in particular availability of fishing activity data for scientists and shift from data calls to pull mechanisms); (5) the potential to strengthen regional coordination.

In addition, in March 2014, the Fisheries Directors General of the 28 Member States were consulted in writing. The Member States agreed with the aims of the DCF revision, namely:

- to retain the core elements of the DCF system as they proved to be efficient, whilst integrating needs stemming from the CFP reform;
- to simplify the DCF by distinguishing between core aspects of EU data collection and aspects that are regional or national;
- to remove redundancies by aligning the DCF and other EU legislation, and to reduce the administrative burden by using IT technology for data transmission, eliminating overlaps and simplifying reporting and sampling.

Member States also came with specific comments. They supported the idea of pooling their data at a regional level and of improving regional planning. They also expressed the need to prioritize data needs and to set only minimum requirements at EU level. They were supportive to adapt the scope of the DCF to new needs of the CFP, but wished to limit costs for example by using a risk-based approach to collecting data on by-catches or pilot studies. Landlocked countries expressed some concerns, in view of the limited resources available, about possible additional data requirements for freshwater aquaculture.

Following the results of a feasibility study, a further written consultation of stakeholders was carried out in the autumn 2014, specifically dedicated to the issues of overlaps between legal requirements and prospects for using IT tools to facilitate data transmission and

¹² Every Member State designates a National Correspondent for data collection who serves as the focal point for exchange of information between the Commission and Member States regarding the preparation and implementation of national programmes and who is responsible for coordination of the different bodies involved in DCF implementation at national level (Article 3 of Commission Regulation (EC) No 665/2008).

¹³ Stakeholder Meeting on the revision of the Data Collection Framework Regulation 16 January, Brussels http://ec.europa.eu/fisheries/cfp/fishing_rules/data_collection/doc/20140116-dcf-stakeholder-workshop-minutes_en.pdf

dissemination. Section 2.2.7 provides greater details on the outcomes of the study and of the consultations.

A public consultation via a green paper on Marine Knowledge also took place in 2012¹⁴ in which fisheries data collection formed a substantive part, in particular concerning the issue of public access to data. The outcome of this consultation gave clear indications about the importance given by the general public to open access to good quality scientific information.

A list of all the consultations that took place can be found in **Annex I**.

2.2. Studies

Several evaluations and other analyses of the Data Collection Framework have been carried out, as summarized below.

2.2.1. Impact Assessment (IA) carried out in the framework of the CFP reform

In 2011, the Impact Assessment (IA) carried out in the framework of the CFP reform¹⁵ assessed, amongst other things, the DCF with its predecessor the DCR and made the following conclusions:

- The DCF generally **meets the purposes for which it was set up**: the production of sound scientific advice and contributes to better fisheries policy making.
- The DCF is a **substantial improvement** over its predecessor, in part by increasing availability of data and also data quality¹⁶.
- Further **rationalisation of the different EU rules** governing collection of data should be strived for to reduce administrative burden.

2.2.2. Interim evaluation on Council Regulation 861/2006

In 2011, an interim evaluation on Council Regulation 861/2006¹⁷ ("second financial instrument")¹⁸ was carried out. This highlighted that the collection of basic data through the National Programmes under the DCF has mostly been relevant and effective, resulting in an improved availability of data for scientific advice. The study concluded that the resulting data is considered to be of relatively good quality, but identified room for improvement regarding timely delivery of data and data formats. The data provided under the DCF was considered to be instrumental to policy making under the CFP. The DCF was considered to have led to improved regional cooperation. The evaluation concluded that by and large, compliance is good.

¹⁴ http://ec.europa.eu/dgs/maritimeaffairs_fisheries/consultations/marine-knowledge-2020/index_en.htm

¹⁵ http://ec.europa.eu/fisheries/reform/impact_assessments_en.htm see in particular Phases I & 2.

¹⁶ For a comparison of the DCR and the DCF, see also the European Parliament report (Policy Department B, Structural and Cohesion Policies), 2008: New Opportunities Offered by the Data Collection Regulation in the Fields of Biology and Economy (Council regulation N° 199/2008/EC) [http://www.europarl.europa.eu/RegData/etudes/note/join/2008/408935/IPOL-PECH_NT\(2008\)408935_EN.pdf](http://www.europarl.europa.eu/RegData/etudes/note/join/2008/408935/IPOL-PECH_NT(2008)408935_EN.pdf)

¹⁷ **Council Regulation (EC) No 861/2006** of 22 May 2006 establishing Community financial measures for the implementation of the common fisheries policy and in the area of the Law of the Sea

¹⁸ Interim evaluation on establishing EU financial measures for the implementation of the Common Fisheries Policy and in the area of the Law of the Sea 2007-2013:

http://ec.europa.eu/fisheries/documentation/studies/cfp_evaluation/index_en.htm

2.2.3. *Ex-post evaluation of the Data Collection Framework*

In 2012, a specific external evaluation was carried out aiming to assess in more details the results obtained by the DCF and to verify that they were consistent with the objectives set¹⁹. The main conclusions of this evaluation were:

- The current data collection framework meets the needs for which it was established: the majority of data users consider that the DCF has produced data that enables the production of sound scientific advice and contributes to better fisheries policy making. Stakeholders consider that the **usefulness and relevance of data** collected under the DCF is relatively high for their needs. The outputs of the process (e.g. advice by ICES) have been increasing over time in quantity and quality.
- The DCF has met the challenges presented by the previous CFP²⁰, by **ensuring the availability of data** that enables the production of sound scientific advice and contributes to better fisheries policy making. The outputs of the DCF process have been increasing over time, as has the data quality. For example, the level of recurrent advice provided by ICES supported by the data collection has increased from 122 items in 2008 to 165 items in 2012.
- The DCF provides **value for money**: the average cost of data collection under the DCF is 2.1% of catch value, placing it at the lower end of the spectrum when compared to fisheries outside the EU (2.5% to 7.5% according to Burke, 2000²¹).
- Observer programs and research surveys at sea are well coordinated and provide **high quality data**.
- The **DCF is a key source** for much of the socio-economic data used to assess the fisheries, aquaculture & processing sector.
- **Compliance** with the obligations by Member States was generally high.

Nevertheless, the evaluation identified some challenges that should be addressed to improve the efficiency and effectiveness of the DCF:

- The system of provision of data to data users through **data calls is very demanding** for Member States, due to the number of data calls and the time spent in re-aggregation data in different ways in response to the various data calls (involving different formats). Data transmission could be made more effective, for example by increasing the accessibility of data to the different users so they can select the data they need and then aggregate it to suit their needs.
- **Overlaps and redundancies** exist relating to data collection or transmission under different EU instruments and these should be minimized.
- Regarding the data to be collected, the DCF was considered to **not be sufficiently data user oriented**, i.e. insufficiently flexible to evolving needs of scientists and

¹⁹ Evaluation of the Data Collection Framework (DCF):

http://ec.europa.eu/fisheries/documentation/studies/retrospective-and-prospective-evaluation-on-common-fisheries-policy_en.pdf

²⁰ Council regulation (EEC) No 3760/92 of 20 December 1992 establishing a Community system for fisheries and aquaculture

²¹ Burke, D L (2000). Management infrastructure for rights based fishing. In, use of property Rights in Fisheries Management. FAO Fisheries Technical Paper 404/1. FAO, Rome. 58-65.

policy makers. Flexibility should be more built into the system of collection and provision of data.

- Incentives for **regional collaboration** should be strengthened.
- "**Metiers**"²² proved not always to be considered the most appropriate unit for sampling, although it was considered to be a useful way in which to aggregate data after it has been collected.

2.2.4. *Assessment of implementation of the DCF through field visits in Member States*

A report²³ was prepared in 2014 by an external contractor summarizing the findings of field visits in 11 Member States²⁴ carried out in 2011-2014. These field visits aimed at analysing the data collection, storage and transmission systems in the Member States. This analysis showed that data collection was well organised in almost all Member States, and has improved over time. The report revealed the following:

- **Quantity and quality** of DCF data have increased over time.
- There are (sometimes too) **many different institutions involved** in data collection in each Member State, which therefore required strong coordination, at sometimes high transaction costs. In many Member States, the national statistical institute is not involved (enough) despite the fact that this could avoid duplication of collection/processing of certain data and improve data quality.
- There are wide divergences in **data storage systems and data transmission** across Member States, and IT systems within and between Member States are generally not compatible. Documentation of the databases is often incomplete and few Member States have a centralised database for DCF data. Improving interoperability of databases within and across Member States would increase the efficiency of data sharing.
- The formats of the various **data calls** launched by data users are often modified over time which constitutes a significant and increasing workload for Member States to adapt the data formats to each data call. This could be addressed either by getting data users to better coordinate their data calls and formats, or by moving to a system of interoperable databases to which data users have access to obtain required data.
- Data should be stored at the **most disaggregated level possible** in databases, to enable different data users to be able to aggregate them to the levels that meet their respective needs.
- The current **quality targets** set by the EU MAP are not realistic, resulting in the precision level targets for biological data not being achieved by Member States. The report recommends reviewing measures of precision and suggests looking at precision at a stock-level (i.e. several Member States) rather than on a Member State

²² A métier is defined as a fishing activity which is characterised by a certain gear, group of target species, operating in a given area during a given season, within which each boat's effort exerts a similar exploitation pattern on a particular (group of) species or group of species. In other words, the species composition and size distribution in catches taken by any vessel working in a particular métier should be approximately the same.

²³ DevStat consortium (2004) "Analysis of cross-cutting issues based on field work carried out in 2011-2014": http://ec.europa.eu/fisheries/documentation/studies/data/documents/analysis-of-cross-cutting-issues-2014_en.pdf

²⁴ Denmark, Belgium, Spain, Greece, Bulgaria, France, Italy, Portugal, Romania, the United Kingdom, Lithuania http://ec.europa.eu/fisheries/documentation/studies/data/index_en.htm

basis as is currently the case. The latter could also result in cost savings through lower sample sizes.

- Although Member States apply **quality control procedures** to the data they collect, the levels of control and methods used vary enormously between Member States and for economic data, most Member States have not implemented formal quality assurance procedures. Generally, quality control should be improved e.g. through setting minimum standards, or by following standards such as the EU Statistics Code of Practice, formalizing procedures and by having methodologies reviewed by national statistical institutes.
- Problems of scientific observers not having **access to commercial vessels** have been reported. This can lead to biases in sampling and the data collected.
- Regarding fisheries dependent data, data on **effort and landings** from the Control Regulation are essential for scientific analysis. In the case of small scale fleets, for which logbooks are not mandatory under that regulation, complementary sampling is recommended as it generates valuable information.
- Regarding fisheries independent data, **research surveys** were considered to have been well carried out, providing good quality and essential data for stock assessments.
- Regarding **recreational fisheries**, in most of the Member States visited, the knowledge about these fisheries is quite scarce, being collected generally only through a few recent pilot projects. However, where data are available, recreational fisheries were found to have an impact that is not negligible on some of the (few) species included in the DCF. This calls for the inclusion of these data in the stock assessments for such species and, therefore, the need for a more regular data collection system, bearing in mind the great number of recreational fishermen and their wide dispersion along coasts and rivers.
- Regarding **aquaculture**, given the difficulty to sample this sector, the study recommended greater harmonization with EU statistical regulation on aquaculture²⁵.
- Regarding **economic data**, the study found the data on fleets to be of good quality. Methods for collection varied between Member States but were not considered to require harmonization. Instead, the outputs should be harmonized so that they can be aggregated at regional or EU level. Regarding the processing sector, the study found

²⁵ **Regulation (EC) 762/2008 of the European Parliament and of the Council** of 9 July 2008, on the submission by Member States of statistics on aquaculture and repealing Council Regulation (EC) 788/96

Regulation (EC) No 1921/2006 of the European Parliament and of the Council of 18 December 2006 on the submission of statistical data on landings of fishery products in Member States and repealing Council Regulation (EEC) No 1382/91

Regulation (EC) No 216/2009 of the European Parliament and of the Council of 11 March 2009 on the submission of nominal catch statistics by Member States fishing in certain areas other than those of the North Atlantic (recast)

Regulation (EC) No 217/2009 of the European Parliament and of the Council of 11 March 2009 on the submission of catch and activity statistics by Member States fishing in the north-west Atlantic (recast)

Regulation (EC) No 218/2009 of the European Parliament and of the Council of 11 March 2009 on the submission of nominal catch statistics by Member States fishing in the north-east Atlantic (recast)

Regulation (EC) No 295/2008 of the European Parliament and of the Council of 11 March 2008 concerning structural business statistics (recast)

that in some Member States, the Structural Business Statistics (SBS)²⁶ is used as a primary source of information for the DCF and that these data are of good quality. The study recommended making more use of statistical data that are collected through the Structural Business Statistics so as to avoid double data collection.

- **Synergies between Member States** should be found to increase efficiencies in data collection and management and spread best practice e.g. sharing IT tools or developing common questionnaires to collect data. Sharing tasks that require very specific knowledge, such as age-reading, was also recommended.
- The current DCF **programming** (National Programmes) **and reporting** (Annual Reports) requirements and formats result in a very heavy workload on Member States and the Commission.
- **Financial restrictions** in some Member States have resulted in lower implementation rates of EU funding and weaker implementation of the DCF.

2.2.5. *STECF evaluations of Member States' Annual Reports*

Successive STECF evaluations of Member States' Annual Reports²⁷ also showed that Member States comply in general well with their obligations to collect and transmit data, and with the requirements on reporting about data collection. However, the STECF evaluations have demonstrated how complex the process of Annual Reporting is, both for Member States to complete and for the Commission and STECF to evaluate. It has proven hard, for example, to distinguish (real) problems of implementation of the DCF, from problems of reporting (whereby implementation is good but not evident due to bad reporting).

Recommendations have been made on how to substantially **simplify the format and to automatize part of the reporting**, such as using of IT tools for reporting, creating automatic reports from certain databases, or using tools to cross-check National Programmes with Annual Reports.

2.2.6. *Interim evaluation of the European Marine Observation and Data Network*

In 2012, an interim evaluation of the European Marine Observation and Data Network (EMODnet)²⁸ strongly supported increasing and simplifying access to fisheries data, and recommended a shift from collecting data for specific purposes by many isolated institutes to collecting data only once and make them generally available and accessible, thereby avoiding duplication, saving costs and ensuring a better and wider use of data.

2.2.7. *Feasibility study on data storage and transmission*

To further investigate the question of data storage and transmission, in 2013-2014, a feasibility study²⁹ was contracted to review the current situation in relation to **DCF data storage, transmission, quality control and dissemination** and to design possible future scenarios for the organization of the fisheries data system (see **Annex II**), in a manner that

²⁶ **Regulation (EC) No 295/2008 of the European Parliament and of the Council** of 11 March 2008 concerning structural business statistics

²⁷ <http://stecf.jrc.ec.europa.eu/reports/dcf-dcr>

²⁸ [SWD\(2012\) 250 final](#) Commission Staff Working Document. Interim Evaluation of the European Marine Observation and Data Network. Accompanying the document Green Paper Marine Knowledge 2020: from seabed mapping to ocean forecasting

²⁹ http://ec.europa.eu/fisheries/documentation/studies/scientific-data-storage/index_en.htm

would improve availability of data, as well as data quality, whilst reducing the workload on Member States for providing data to data users. The study also detailed existing procedures to ensure data quality, protection of personal data and confidentiality of commercial data.

The study confirmed that answering **data calls represents a large burden on Member States**, due in part to the increasing number of data calls but also to the diversity of aggregation levels required by different data users and the fact that these often change over time. The study also identified many areas of **overlap in the legislative frameworks on data collection** (this is elaborated further in section 5.9.1 and see also **Annex III**).

The study identified some **key principles that any future system should comply with**:

- Primary³⁰ or at least **detailed data should be the basic building block** stored in national databases, rather than the current aggregations to fleet segments (as per the requirements of the current DCF), as the latter limits the way in which data users can aggregate data (including biological, economic and fishing activity data) and leaves the burden on Member States' data collection services to carry out the required aggregation work.
- A clear distinction must be made between **production** (where data are processed and validated) and **dissemination databases** (from which data are made available to data users, usually in a more aggregated manner). This is common practice in all statistical institutes. It allows for processes like correction of errors or estimation of missing data so that a consistent data set is presented to data users.
- The system should use **common accepted nomenclatures** (species, gears, fishing areas). This is already the case in some areas (species), but for other variables, common nomenclatures still need to be agreed upon e.g. gears.
- Data and databases should continue to be **organized along thematic modules** (biology, economics, fisheries/control data) as they follow very different structures. These modules or databases should be linked.
- **Data quality procedures** should be strengthened and encompass the whole process from planning of the sampling until dissemination. This whole process should be properly documented to ensure transparency, transfer of experience and further development.
- **Scientists who are closely involved** in policy related research (e.g. STECF, GFCM, ICES) should be also closely involved in development of the system so that it responds to their needs (i.e. to their ability to answer policy questions).
- Under any scenario, **protection of personal data** has to be, and can be, ensured, and shall be subject to applicable rules on protection of personal data.

The Commission services consulted Member States experts and key data users (RCM chairs, ICES, GFCM) at the end of 2014 on the main findings of the study as set out above. There was significant consensus on the key principles to be followed, except with the first point, whereby most respondents were in favour to make only detailed data the building blocks for data exchange. Based on the responses, there was a large consensus as regards existing overlaps between different data flows and the awareness that it could be avoided by

³⁰ The current DCF regulation defines 'primary data' as *data associated with individual vessels, natural or legal persons or individual samples*; and 'detailed data' as *data based on primary data in a form which does not allow natural persons or legal entities to be identified directly or indirectly*;

streamlining EU legislation. Respondents agreed that the current data call system is very burdensome and that both protection of personal data as well as greater transparency regarding structures and processes are important.

3. STRENGTHS AND WEAKNESSES OF THE CURRENT LEGAL FRAMEWORK

Based on the consultations and studies described above, the strength, weaknesses, opportunities and threats (SWOT) of the DCF have been established (see also **Annex IV**), and the following conclusions can be drawn:

- **Data quantity:** The DCF has significantly increased the quantity of fisheries data. The DCF is generally considered to be fit for purpose, and most data collected are relevant and useful to data users. The DCF has provided an EU-wide framework with harmonized procedures, and has enabled development of time series of data.
- Nevertheless, the current data collection system has focused on providing data primarily for fisheries management, while under the reformed CFP, data will be needed also to support several new or strengthened policy objectives: the **move to ecosystem-based fishery management**; a new emphasis on the development of **sustainable aquaculture**; an improved **impact assessment** of decisions on fisheries management, such as the landing obligation. An adjustment to the scope of data to be collected and the way this is done is therefore required. This would, in the case of ecosystem data, also contribute to strengthening links with data collection required under environmental law.
- **Data quality** is now considered to be relatively good but there remains scope for improvement. Some problems with the current system include inappropriate and unrealistic quality targets, which can lead to an inefficient use of resources. **Quality assurance and control procedures** vary greatly between Member States and should in general be further strengthened, in particular for socio-economic data.
- **Data availability** is the area where most progress should be made. The main issues are the following: i) timeliness of data provision by Member States to end-users has not always been satisfactory; ii) the process through which end-users requests data from Member States is very resource intensive due to numerous and varied (formats of) data calls; iii) internal organisation in Member States of data storage and transmission systems is often too complex, and IT systems are often incompatible among and within Member States; and iv) restrictions exist, in a non-harmonized way, on access to data for scientific purposes. Availability of data should therefore be increased and processes simplified.
- As the need for information on marine environment is increasing, there is an opportunity for **multi-purpose collection of data** that should not be missed. This will follow-up on the Commission's Communication on innovation in the Blue Economy as well as facilitate implementation of the Marine Strategy Framework Directive (MSFD)³¹ (see Chapter 4).

³¹ **Directive 2008/56/EC of the European Parliament and of the Council** of 17 June 2008 establishing a framework for community action in the field of marine environmental policy <http://eur-lex.europa.eu/legal-content/EN/TXT/?uri=CELEX:32008L0056>

- **Flexibility:** The DCF has been an improvement in setting common rules for all Member States, which allow policy makers (including at national level) to base their decisions on a similar, comparable set of information. However, the legal set-up of the DCF is generally considered excessively prescriptive and detailed. This has resulted in a cumbersome and insufficiently responsive system, which has sometimes prevented timely changes to accommodate new needs and insufficient adaptation to specific regional or national realities. It is therefore necessary to better incorporate end-users in the design and implementation of the DCF to ensure closer alignment between data needed and data collected.
- **Complexity:** The DCF is considered by all as too complex, both the legal framework, and in terms of reporting and data transmission procedures. Improvements have been called for to increase efficiency of the system and to reduce administrative burden. One source of complexity and inefficiency that has been repeatedly pointed out is the **duplication** between data covered by the DCF and other EU legislation such as the Control Regulation³² and EU statistical regulations³³. Another area is to increase **synergies** with the objectives of other EU legislation. This is primarily the case for the MSFD³⁴: through its revision, the DCF should ensure that data can be used also for the purpose of implementing the MSFD (see Chapter 4).
- **Regional cooperation** is widely heralded as one of the key strengths of the DCF and should be further strengthened in line with the direction taken by the CFP reform. To support the regionalisation of the fisheries management measures by adequate scientific advice at regional level, there is an opportunity to further encourage cooperation between Member States also in the area of data collection.

4. THE BROADER CONTEXT

Section 3 presents the **intrinsic** reasons why the DCF needs to be revised. Beyond these reasons, **extrinsic** developments result in further reasons to revise the DCF in order to align it with other relevant EU policies and legislations.

³² **Council Regulation (EC) No 1224/2009** of 20 November 2009 establishing a Community control system for ensuring compliance with the rules of the common fisheries policy, amending Regulations (EC) No 847/96, (EC) No 2371/2002, (EC) No 811/2004, (EC) No 768/2005, (EC) No 2115/2005, (EC) No 2166/2005, (EC) No 388/2006, (EC) No 509/2007, (EC) No 676/2007, (EC) No 1098/2007, (EC) No 1300/2008, (EC) No 1342/2008 and repealing Regulations (EEC) No 2847/93, (EC) No 1627/94 and (EC) No 1966/2006

³³ **Regulation (EC) 762/2008 of the European Parliament and of the Council** of 9 July 2008, on the submission by Member States of statistics on aquaculture and repealing Council Regulation (EC) 788/96
Regulation (EC) No 1921/2006 of the European Parliament and of the Council of 18 December 2006 on the submission of statistical data on landings of fishery products in Member States and repealing Council Regulation (EEC) No 1382/91

Regulation (EC) No 216/2009 of the European Parliament and of the Council of 11 March 2009 on the submission of nominal catch statistics by Member States fishing in certain areas other than those of the North Atlantic (recast)

Regulation (EC) No 217/2009 of the European Parliament and of the Council of 11 March 2009 on the submission of catch and activity statistics by Member States fishing in the north-west Atlantic (recast)

Regulation (EC) No 218/2009 of the European Parliament and of the Council of 11 March 2009 on the submission of nominal catch statistics by Member States fishing in the north-east Atlantic (recast)

Regulation (EC) No 295/2008 of the European Parliament and of the Council of 11 March 2008 concerning structural business statistics (recast)

³⁴ <http://eur-lex.europa.eu/legal-content/EN/TXT/?uri=CELEX:32008L0056>

Institutional changes – the Lisbon Treaty: The DCF is no longer aligned with the provisions foreseen under Lisbon Treaty³⁵, which resulted, amongst others, in changes to comitology procedures. Rules applicable to comitology procedures therefore need to be updated.

Changes in the financial instrument – the European Maritime and Fisheries Fund: Until 2013, data collection was financed under the so-called "Second financial instrument" (Council Regulation (EC) No 861/2006) under a system of direct management and detailed rules on implementation were set out in Commission Regulation (EC) No 1078/2008³⁶. As of 1.1.2014, the legal basis for financing of data collection in the EU is the EMFF, which foresees funding under shared management of Member States' data collection activities, as well as additional funding in direct management to support cooperation between Member States in the field of data collection. Specific references in the DCF to the previous financial instrument and regulations have now become obsolete.

Open access to research data: The Commission's **Communication on better access to scientific information**³⁷, calls for a wide availability of publicly-funded research results that exist in the form of data, in all scientific fields, in order to improve transparency of the scientific process, to foster collaboration, avoid duplication of effort and accelerate innovation.

In this context, according to the **Green Paper on Marine Knowledge 2020**³⁸, due to fragmentation, duplication of data generation and unawareness of what information is available, a great amount of resources (human, financial and natural) are wasted and certain synergies remain unused. If several types of data were interconnected or if data were made available for more than one purpose, tremendous savings could be made. This is because several marine activities that are apparently unrelated such as offshore mining, blue energy, tourism, fisheries and aquaculture have great impact on each other and when assessing that impact, information from widely different sources need to be combined. The European Parliament supported the conclusions of the Communication³⁹.

Following on the Green Paper, the Commission's **Communication on innovation in the Blue Economy**⁴⁰ identified several issues that currently hinder innovation in the blue economy, of which a key problem is the gaps in knowledge about the sea, the seabed and the life it supports. The Communication noted that different sets of marine data are held by many different organisations and that identifying who holds data and obtaining authorisation to use them can be time-consuming and expensive.⁴¹ Furthermore, higher quality and more readily available marine data would facilitate implementation of the MSFD (see below). On this basis, the Commission aims to ensure that marine data is easily accessible, interoperable and free of restrictions on use.

³⁵ [Consolidated version of the treaty on the functioning of the European Union \(C\) No 326/47](#)

³⁶ **Commission Regulation (EC) No 1078/2008** of 3 November 2008 laying down detailed rules for the implementation of Council Regulation (EC) No 861/2006 as regards the expenditure incurred by Member States for the collection and management of the basic fisheries data

³⁷ http://ec.europa.eu/research/science-society/document_library/pdf_06/era-communication-towards-better-access-to-scientific-information_en.pdf

³⁸ http://ec.europa.eu/maritimeaffairs/documentation/publications/documents/marine-knowledge-2020-green-paper_en.pdf

³⁹ European Parliament report on Marine Knowledge 2020: improving seabed mapping for fisheries purposes (2013/2101(INI)) Committee on Fisheries (Rapporteur Maria do Céu Patrão Neves)

⁴⁰ <http://eur-lex.europa.eu/legal-content/EN/TXT/PDF/?uri=COM:2014:254:REV1&from=EN>

⁴¹ Commission Staff Working Document Marine Knowledge 2020: roadmap <http://eur-lex.europa.eu/legal-content/EN/TXT/?uri=SWD:2014:149:FIN>

EU Biodiversity Strategy to 2020: In 2011, the European Commission adopted an ambitious strategy to halt the loss of biodiversity and ecosystem services in the EU by 2020. The so-called 'EU Biodiversity Strategy 2020'⁴² sets two long-term goals:

- The 2020 Headline Target – to halt biodiversity loss and ecosystems degradation
- The 2050 Vision – where EU's natural capital is protected

It also contains six main targets, of which Target 4 aims at better management of fish stocks.

The Marine Strategy Framework Directive⁴³: One of the key tools to achieve the EU Biodiversity Strategy 2020 is the MSFD, the environmental pillar of the Integrated Maritime Policy. The MSFD aims at reaching "good environmental status" of the EU's marine waters by 2020. It sets out different requirements and methods to achieve this. In particular, the environmental status of marine waters will be assessed, among other tools, by 11 qualitative **descriptors** (see **Annex V**). Descriptor 3 focuses on the state of commercial fisheries, and requires that: "*Populations of all commercially exploited fish and shellfish are within safe biological limits, exhibiting a population age and size distribution that is indicative of a healthy stock*". The DCF is the key source of data for calculation of this Descriptor. In addition, there are other MSFD Descriptors that are less directly related to fisheries, but for which the DCF already provides some of the necessary data, for example Descriptors 1 (Biological diversity), 4 (Food-webs) and 6 (Sea-floor integrity).

The revised DCF would therefore help achieve not only goals set out by the MSFD but would also contribute towards the 2020 Biodiversity Target and 2050 Vision.

The interactions between the DCF and some of the above elements are summarised in **Figure 2**.

⁴² Communication from the Commission to the European Parliament, the Council, the Economic and Social Committee and the Committee of the Regions: Our life insurance, our natural capital: an EU biodiversity strategy to 2020 {SEC(2011) 540 final}{SEC(2011) 541 final}

⁴³ <http://eur-lex.europa.eu/legal-content/EN/TXT/?uri=CELEX:32008L0056>

Figure 2: Interactions between the DCF and other EU policies and legislation

Arrows indicate the direction of data flows.

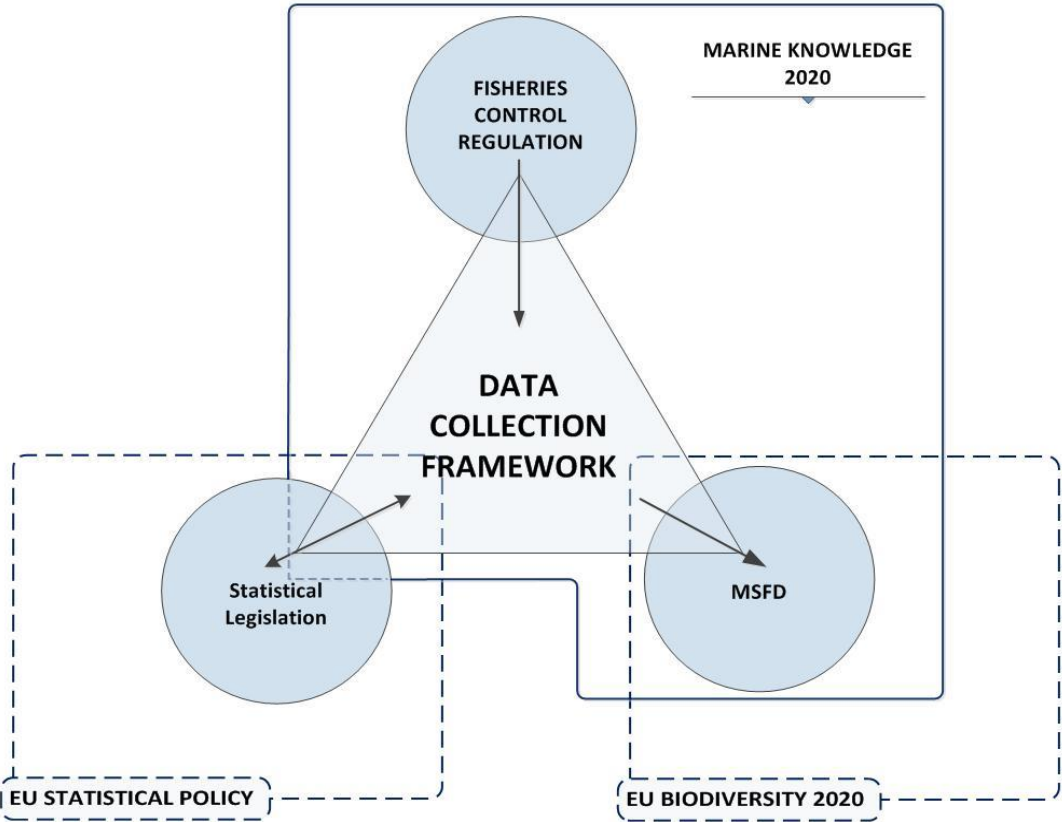

5. PROPOSED CHANGES TO THE CURRENT LEGISLATION

This section presents, for each change to the DCF that is presented in the *Proposal for a Regulation of the European Parliament and of the Council of... concerning the establishment of a Union framework for the collection, management and use of data in the fisheries sector and support for scientific advice regarding the Common Fisheries Policy (recast)*, the specific problems with the current DCF and the rationale for choosing the proposed option when several options were available. For major topics, for which different options were considered, the process for identifying the proposed option is also included in tabular format to simplify presentation of the issues.

The Commission proposal relates to co-decided legislation. However, for transparency purposes, and because legislation, rules giving effect or supplementing it and practical implementation are so intertwined in such a technical area, possible adjustments to current implementing rules (essentially the EU Multi-annual Programme⁴⁴) or practice are also presented when these can already be envisaged as a result of the evaluations and consultations carried out by the Commission. This should in no way encroach on the Commission's institutional prerogatives to adopt implementing rules, nor does this prejudice further additional consultations, based on the ultimate decision of the co-legislator.

5.1. The future data collection process

5.1.1. End-user oriented data collection

Background and legal provisions of the DCF

The *raison d'être* of the DCF is to ensure that relevant data are available to scientific end-users to achieve the objectives of CFP. The current DCF defines end-users as bodies with a research or management interest in the scientific analysis of data in the fisheries sector (Article 2).

The current DCF considers end-users of DCF data only in the context of providing them with data: on the one hand concerning Member States' obligations to make data available to end-users (Articles 18-21) and on the other hand, concerning end-users' obligations regarding what they can and cannot do with these data, and relating to providing feedback on data transmission failures by Member States (Article 22).

The current DCF has been criticized by a broad range of stakeholders including the STECF, Member States and end-users, for not reflecting sufficiently the needs of end-users in terms of deciding on what data should be collected or how this should be done, and not being flexible enough to address their evolving needs, e.g. new stocks being exploited, changes to technical measures regulations, development of scientific advice, move to statistically sound sampling schemes etc.

Indeed, currently, the DCF Regulation (Art. 3) contains provisions for the establishment of 3-year multiannual EU programmes⁴⁵ but no provisions are included regarding modifications of

⁴⁴ **Commission Decision 2010/93/EU** of 18 December 2009 adopting a multiannual Community programme for the collection, management and use of data in the fisheries sector for the period 2011-2013 C(2009) 10121), as extended by Commission Implementing Decision of 13.8.2013 extending the multiannual Union programme for the collection, management and use of data in the fisheries sector for the period 2011-2013 to the period 2014-2016 (C(2013)5243

⁴⁵ with an exception for the first multiannual programme that covered only two years

these three year programmes, or how the needs of end-users should be taken into account to draw them up or modify them.

Table 2: Need the DCF should address: Provide a flexible, end-user driven data collection system

Problems identified	Objectives of revision	Options for addressing problem	Proposed solution
<p>The DCF does not reflect sufficiently the needs of end-users in terms of the data covered to be followed</p>	<p>Member States should collect data only where there is an end-user need.</p>	<ol style="list-style-type: none"> 1. Include criteria in the DCF Regulation to determine what data should be included, including the end-user need for the data. 2. Develop the new EU MAP, and future revisions of it, based on consultation of end-users. 3. Not include data to be collected in EU MAP but let end-users decide on these directly with Member States in Regional Coordination Groups. 	<ol style="list-style-type: none"> 1. Include criteria in the DCF Regulation to determine what data should be included in the EU MAP, including the end-user need for the data. 2. Design the new EU MAP, and future amendments to it, based on consultation of end-users.
<p>The DCF is not flexible enough to address evolving needs of end-users over time</p>	<p>The system should allow for modifications to the data covered or methodologies to be used</p>	<ol style="list-style-type: none"> 1. Provisions on <i>what</i> should be collected should be established in the EU MAP. Member States in Regional Coordination Groups can decide to collect additional data based on end-user input. 2. Provisions on <i>what</i> should be collected should not be included in EU MAP but left to end-users to decide on directly with Member States in Regional Coordination Groups⁴⁶. 2. Methodological aspects should no longer be specified in the EU MAP but coordinated by Member States in Regional Coordination Groups or the EU Coordination Group⁴⁷. 4. The DCF Regulation should contain provisions on the amendment of the EUMAP. 	<ol style="list-style-type: none"> 1. Provisions on <i>what</i> should be collected should be established in the EU MAP. Member States in Regional Coordination Groups can decide to collect additional data based on end-user input. 2. Methodological aspects should no longer be specified in the EU MAP but coordinated by Member States in Regional Coordination Groups or the EU Coordination Group. 3. The DCF regulation should contain provisions on the amendment of the EUMAP.

⁴⁶ See section 5.1.2 for more details on Regional Coordination Groups.

⁴⁷ See section 5.1.2 for more details on the EU Coordination Groups.

Changes to the DCF

The definition of "end-users" in the current DCF Regulation is meant to have the same meaning as "end-users of scientific data" in Regulation (EU) No 1380/2013, and does not need to be modified. It is meant to include also scientific bodies with an interest in the environmental aspects of fisheries management. Other interested parties are to be understood as Advisory Councils established under Article 43 of Regulation (EC) No 1380/2013, or members of the scientific community or members of the public who are interested by data in the interest of scientific publication, public debate and stakeholder participation in policy development.

In the future data collection system, there should be **four key areas of the data collection process in which end-users of DCF data should be better involved**:

- (1) end-user input (advice) in determining what should or should no longer be collected;
- (2) end-user involvement in designing the sampling programmes that Member States must carry out to collect those data that end-users will use;
- (3) end-user access to DCF data;
- (4) end-user feedback on the data they have accessed.

Of the four areas above, the first is summarized below (see **Annex VI** for further detail on this process). The issue of end-user involvement in designing the sampling programme is dealt with in section 5.1.2 whilst the last two – access to data and feedback – are dealt with in section 5.5.

Despite the undoubted advantage of involving end-users more in defining the data to be included in the EU MAP, this comes with **risks**. Changing needs may entail frequent changes of data requirements, whilst there is a need to keep proper balance between flexibility and continuity (one of the strengths of the DCF being its building of time series). It is also necessary to avoid increasing the cost of data collection as requests from end-users tend to demand more rather than less data. In addition, every time there is a change in the EU MAP, this will require Member States' to amend their sampling plans.

Therefore, although this could be considered as a faster process, it does not seem appropriate to allow end-users to express their needs directly to Member States regarding what data should be collected (for example in the context of Regional Coordination Groups), and it is preferable to maintain an EU-level filtering or prioritizing process, through adoption of the EU MAP – and its modifications – by the Commission.

On this basis, end-user input would take place in two ways:

1. Regarding **data covered by the EU MAP**, end-users would be able to express their needs to the Commission (see **Annex VI** for further details on the process of establishing and amending the EU MAP).
2. For **additional data** (beyond the data collected under the EU MAP), or regarding aspects of *how* data should be collected, end-users could **express their needs directly to Member States in Regional coordination Groups (RCGs)** (see section 5.1.2 for more details on RCGs). If these changes are agreed in those fora, Member States would amend their work plans accordingly, without the need for modification of the EU MAP.

The above would be achieved by including provisions in the DCF Regulation:

i) Providing for the **consultation** by the Commission of **Regional Coordination Groups, the STECF** and any other relevant scientific advisory body, such as the EU Coordination Group, during the preparation and any amendment of the **EU MAP**.

ii) Establishing **criteria** which the Commission would take into account **when deciding whether to include/remove a species/variable** from the EU MAP. The criteria, based in large part on advice from the STECF⁴⁸ would include the needs of the scientific community and the need and relevance of data for decisions on fisheries management and protection of the ecosystem including vulnerable species (see **Annex VI** for full list of possible criteria).

5.1.2. Strengthening regional and EU coordination

Background and legal provisions of the DCF

Regional coordination, achieved mainly through annual Regional Coordination Meetings (RCMs), is considered one of the big achievements of the DCF. Over the past years, there has been a clear strengthening of regional coordination, in particular in the Baltic and the North Sea, and Member States have expressed their interest in further strengthening regional coordination, including through the Oostende Declaration⁴⁹ that was submitted by chairs of Regional Coordination Meetings to the Commission.

The current DCF Regulation already contains provisions whereby Member States should coordinate their National Programmes with other Member States in the same marine region, and should amend their National Programmes based on recommendations of Regional Coordination Meetings. In practice however, Member States design their National Programmes and then try to align them/task share in Regional Coordination Meetings (Art. 5).

In some regions and for some data (e.g. collection of biological data on EU fisheries off West Africa – see **Textbox**), Member States have established **bi- or multi-lateral agreements** to task share in their collection of data, resulting in considerable savings for all Member States involved compared to if they had to establish and run individual data collection programmes. Carrying out joint sampling also results in overall cost reduction and avoidance of duplication or excess of data collected.

In practice, regional coordination for data collection applies almost exclusively to biological data, for which regional differences are more pronounced, whilst coordination of methodologies for economic data collection are done at EU-level through the Planning Group for Economic Issues (PGECON), that is not established in the DCF but has emerged from a need for greater cooperation between Member States.

⁴⁸ **Member States Experts (11-15 March 2013, Ispra, Italy)** Dedicated STECF EWG meeting 13-02 on the new DC MAP. Report available: [Scientific, Technical and Economic Committee for Fisheries \(STECF\) – Review of the DC MAP – Part 1 \(STECF-13-06\)](#)

⁴⁹ <http://datacollection.jrc.ec.europa.eu/documents/10213/488770/9th+Liaison+Meeting++FINAL+REPORT.pdf> (see Annex 2)

Textbox 2 - Cost savings through the development of a joint sampling programme off West Africa

For 2012 and 2013, five Member States (Germany, Latvia, Lithuania, Netherlands and Poland) signed a multilateral agreement to carry out a joint sampling programme for their long-distance fisheries in the CECAF waters, off West Africa.

The joint CECAF sampling programme is based on 12 trips (3 per quarter) per year carried out by employees of the Mauritanian Fishery Research Institute coordinated by a fishery scientist from the Netherlands. Total costs, of around 65 000 Euro, are split between the Member States involved based on their historical share of catches in the area.

The costs for Member States under this multilateral agreement were several times lower than before, when they each had to carry out individual sampling programmes, and had to cover travel and coordination and data management costs for observers from each Member State. For example, Germany's annual costs were around 5 times higher, and Poland's three times higher, before joining the multilateral agreement.

Source: information received from Member States under their DCF Annual Reports and by correspondence

Article 25 of the CFP Regulation reiterates the principle that Member States should coordinate their data collection activities with other Member States (and third countries, where possible) in the same region. Beyond this article on data collection, the CFP Regulation provides for enhanced regional coordination between Member States in certain areas such as the development and implementation of conservation measures.

Table 3: Needs the DCF should address: Build on the improved regional coordination achieved over the last 10 years by strengthening the role of regions in planning, implementing and evaluating data collection.

Problems identified	Objectives of revision	Options for addressing problem	Proposed solution
EU framework for data collection is very complex and does not take sufficiently into account regional specificities	Allow certain aspects of data collection to be coordinated by Member States in Regional Coordination Groups (for biological data) or to the EU Coordination Group (mainly for economic data).	A range of scenarios with at one end all data and details specified at EU level, and at the other end nothing specified at EU level and all aspects of data collection (what and how) coordinated by Member States in Regional Coordination Groups or the EU Coordination Group.	Keep key aspects of <i>what</i> should be collected specified at EU level, (what species, variables, coverage, periodicity and aggregation level) but leave methodological aspects to be coordinated by Member States in Regional Coordination Groups and the EU Coordination Group. For additional areas of data collection, Regional Coordination Groups to agree on all aspects of data collection (including what & how)
National approaches to sampling may result in oversampling and inefficient use of resources	Increase cost-efficiency of sampling planning and collection	<ol style="list-style-type: none"> 1. Continue business as usual – plan sampling at national level then coordinate at regional level. 2. Regional Coordination Groups may plan sampling at regional level and agree on task allocation between Member States. 	EU MAP specifies basic rules on which Member States should sample which species/variables. Beyond this, Regional Coordination Groups may coordinate further sampling at regional level and agree on task allocation between Member States.
DCF no longer in line with spirit of new CFP regarding regionalisation	Align with regionalisation of new CFP conservation measures/target-made data for sea basin policies.	<ol style="list-style-type: none"> 1. Establish Regional Coordination Groups as legal entities (like Advisory Councils). 2. Strengthened Regional Coordination Meeting structures (no legal entity) for Regional Coordination Meetings, with broadened scope of areas they may work on. 	Strengthened Regional Coordination Meeting structures (no legal entity) for Regional Coordination Meetings, with broadened scope of areas they may work on.

Changes to the DCF

In line with strengthened provisions on regionalization in the CFP Regulation, the revised DCF Regulation should provide regions with a greater range of tasks concerning planning and implementing data collection. This would be achieved through the **establishment of Regional Coordination Groups (RCGs)**, to deal with regional issues (essentially, biological/stock issues), as well as an **EU Coordination Group (EUCG)**, to deal with EU-wide issues (essentially socio-economic data, but perhaps also covering areas such as environmental impacts of aquaculture). The RCGs and EUCG would enable Member States to work on regional or EU cooperation throughout the year, rather than just through an annual meeting as is currently the case for RCMs and PGECON, and would no longer depend on the Commission, with the assistance of a Chair, calling and organizing the meetings.

The **DCF Regulation** would detail the membership of RCGs. This would consist of experts from Member States, the Commission and relevant end-users of data..

The DCF Regulation would set out the main tasks of the RCGs. These groups would no longer simply consider already established national work plans and coordinate their implementation, but may instead be involved in all steps of the process from the development of national work plans, through to agreeing on how sampling should be carried out to finally evaluating the quality of the data collected at regional/stock level. There was broad support during consultations to strengthen regional coordination in this way.

The RCGs would essentially have four main tasks, relating to regional cooperation, which are summarized below and further detailed in **Annex VIII**.

1. Data to be collected:

i) **Advising the Commission**, when establishing the EU Multiannual Programme and amendments thereof.

ii) **Agreeing on additional data to be collected at regional level**

2. For all data to be collected (whether covered by the EU MAP or agreed in RCG), agreeing on **methodological aspects of data collection** such as identifying guidelines and best practice methodologies to be followed, agreeing on sampling strategies and agreeing on **sampling levels** (i.e. the latter will no longer be specified in the EU MAP).

3. **Planning and coordinating the sampling at regional level⁵⁰**: RCGs may develop and coordinate the implementation of a regional work plan and sampling strategy in order to achieve an adequate division of tasks among the Member States for e.g. biological data on shared stocks, or on by-catch of protected species. This would replace the current approach of national planning of sampling.

4. **Contributing to the quality assurance and control** of data. RCGs would be tasked with establishing guidelines for quality assurance and control and identifying best practices and methodologies that Member States should follow.

RCGs could submit a **regional work plan** to the Commission including agreed procedures and methods, as well quality assurance and control measures, and a regionally-coordinated sampling strategy. Such a regional work plan may replace parts of the work plans drawn up by each Member State.

⁵⁰ Planning and implementing of sampling at a regional level is not relevant for socio-economic data, for which data collection makes most sense at national level, and hence the EUCG would not be involved in this task.

The **EUCG** would have similar tasks to the RCGs, apart from task 2 above which is not relevant for the EUCG, but for data sets for which EU-wide, as opposed to regional coordination is more relevant (essentially socio-economic data and data on sustainability of aquaculture).

In terms of **governance structure**, one option would be to establish RCGs and the EUCG as legal entities (such as an Advisory Council or Regional Sea Conventions (RSCs)). This would increase clarity of the obligations or rights of participants, but would be less flexible and would require additional legal acts and delays in establishing such structures. Providing EU funding to such legal entities is not foreseen in the EMFF Regulation. Consultations with Member States revealed that such a formal set up for RCGs or EUCG would go beyond what they desire.

The preferred approach is therefore to rather strengthen the current RCM mechanism (established in the DCF with specific tasks), without giving them a legal entity, but extending their tasks as set out above. As opposed to the current provisions in DCF Regulation, whereby the Commission organizes the Regional Coordination meetings, the future **DCF Regulation** would specify that RCGs should be established by the relevant Member States in each marine region.

With regards to an EU Coordination Group, this would be established as an expert group of the Commission and would take over the current tasks of the PGECON, expanded as necessary into other areas (for example to allow for coordination between National Correspondents for data collection and to allow for coordination between RCG chairs on supra-regional issues, which was dealt with in the past through a so-called "DCF Liaison Meeting⁵¹").

Beyond legal provisions, three areas can be further developed to strengthen regional coordination:

- Regional cooperation, and in particular of planning of sampling at regional level, will be greatly **facilitated through IT developments** that will ensure progressively the interoperability of information systems in the Member States as well as harmonizing protocols for availability of data (see Chapter 5.5).
- Regional cooperation will be encouraged by providing **EMFF funding under direct management** in addition to the co-financing of national actions under shared management (see Chapter 7).
- As coordination within Regional Coordination Groups and the EU Coordination Group increases over time, there is a risk of widening differences, or even divergences that may result in a reduced homogeneity at EU level. Therefore, **coordination between groups** on issues affecting several regions (e.g. stocks like eels found in several regions) should also be foreseen. This would be one of the tasks of the EU Coordination Group.

⁵¹ The Commission organizes annually a DCF Liaison Meeting A Liaison Meeting between the chairs of STECF DCF Expert Working Groups, the chairs of the different RCMs, the chair(s) of other DCF-related meetings/groups and key end-users such as GFCM and ICES in order to ensure overall coordination between the RCMs.

5.2. The scope of the future DCF – what data should Member States collect and how to avoid overlaps

The scope of the DCF should be aligned with new needs arising from the revision of the CFP Regulation. This requires adjustments relating to:

- The impact of fisheries on the marine biological resources and ecosystems, and more specifically, synergies with the MSFD,
- The need to provide data to carry out impact assessments of policy measures,
- The manner in which sampling is carried out under the landing obligation,
- Socio-economic data on freshwater aquaculture, and sustainability of aquaculture in general.

In addition, the scope of the DCF should also include alignment between the DCF and other relevant EU legislation and initiatives relating to data collection and data provision so as to reduce overlaps and therefore reduce costs of the entire system of marine data.

In particular, the DCF will only create data collection obligations insofar as they are not already covered by other EU legislation (see **Annex III**). However, the DCF will be the major legal instrument by which the obligation is created upon Member States to provide any data necessary to data users, whatever the source of the legal obligation under which the data are collected (DCF or any other EU legislation), unless the other legal instrument already provide for the availability of the data (e.g. most statistical Regulations).

5.2.1. Data on marine biological resources

5.2.1.1. Data on fish stocks

Background and legal provisions of the DCF

The current DCF covers data collection as regards commercial – and in some cases recreational – fisheries carried out by EU vessels both within and outside EU waters, and includes inland waters fisheries only as regards eels and salmon (Article 3). The DCF Regulation also requires Member States to establish a scheme for at-sea monitoring of commercial and recreational fisheries, where necessary (Article 4).

The list of stocks to be sampled (over 425) is included in Appendix VII of the EU Multiannual Programme. For the majority of stocks, only commercial data need to be collected but for a few stocks, recreational fisheries data also needs to be collected. The detailed data that should be collected are also specified, per stock, in the EU Multiannual Programme, and include variables such as volume and length distribution of retained catches and of discards, age, weight, sex, maturity and fecundity of individual fish, as well as the frequency of collection of these parameters (see Chapter III and Appendix VII of the EU Multiannual Programme).

The consultations on the DCF, including the external evaluation, have been unanimous in outlining how important the DCF's achievements have been in terms of ensuring the collection and provision to end-users of **time series of harmonized data sets**, collected in a **standardized way** across the EU. However, the DCF has also been criticized by many stakeholders, and in particular Member States who need to implement it, for its excessive complex, detailed and prescriptive nature.

Regarding **recreational fisheries**⁵², lighter data collection obligations currently apply (Article 3), and only for a **limited number of species** for marine fisheries (eel, salmon, seabass, cod, sharks, Bluefin tuna) as well as inland fisheries (eels and salmon). For these species, Member States must collect **basic data in the form of quarterly weight of the catches** (Article 9).

Evaluations of the DCF have revealed that the **knowledge about recreational fisheries is still relatively low**, and that the DCF is a key data source on recreational fisheries. However, recreational fisheries are known to potentially have an important impact on the stocks. For example, in Germany, recreational fisheries contribute to around 50% of total offtake of cod in the western Baltic⁵³.

Over the period of the current DCF, Member States were given the possibility to first carry out a **pilot project** on recreational fisheries, to determine the importance of recreational fisheries and the feasibility of setting up a data collection programme. Member States should now all be in a position to carry out data collection on their important recreational fisheries.

Table 4: Needs the DCF should address: Provide reliable data on fish stocks for the needs of the new CFP, notably to enable ecosystem-based management.

Problems identified	Objectives of revision	Options for addressing problem	Proposed solution
Overly prescriptive provisions at EU level regarding how data should be collected, leading to very complex and inflexible legislation	Simplify the EU legislation and broaden the scope of tasks for Member States in Regional Coordination Groups regarding data collection.	Specify what data should be collected and how they should be collected in the EU MAP Specify only what data should be collected in the EU MAP, and let Member States in RCGs or the EUCG coordinate on how this should be done. No specific data requirements in the EU MAP, but let Member States in RCGs agree on what data should be collected and how it should be collected.	Specify only what data should be collected in the EU MAP, and let Member States in RCGs coordinate on how this should be done.

⁵² Defined in the DCF Regulation as *non-commercial fishing activities exploiting living aquatic resources for recreation or sport*

⁵³ RCM Baltic 2012 report <http://datacollection.jrc.ec.europa.eu/documents/10213/da72f76b-8b58-4670-9135-f7741074de73>

Changes to the DCF

Commercial fisheries

With a view to address excessively prescriptive provisions at EU level and cater for an increased tailor-made decision making at regional level, several options could be considered regarding the extent to which data collection requirements are specified at EU level versus being agreed at regional level (see **Table 4** above).

As is the case currently, the revised **DCF Regulation** would contain an obligation for Member States to collect biological data on all stocks targeted or by-caught by Union vessels in Union and external waters to enable ecosystem based management and conservation.

The details regarding for example which stocks and which variables, the coverage, and periodicity of collection, would be specified in the **EU MAP**.

To ensure consistency of data collected and the need to maintain time series, and on the basis that these parameters should not vary much over time, key parameters on **what** data should be collected (species, area/stock, type of data to be collected), **how frequently**, and to what level of disaggregation would be included in the future **EU MAP** (see **Annex IX** for further details).

By contrast, provisions on **how** the data are to be collected, and the intensity of sampling required, which are likely to evolve over time and may be sea-basin specific, would be determined by Member States through coordination in RCGs as part of the RCGs' new task of coordinating biological sampling at a regional level (see Section 5.3.).

Recreational fisheries

The **CFP Regulation**, in a recital, recalls that recreational fisheries can have a significant impact on fish resources and Member States should, therefore, ensure that they are conducted in a manner that is compatible with the objectives of the CFP. In order to fully evaluate total impacts of fisheries on the fish resources, data collection on recreational fisheries should continue. The **DCF Regulation** provisions requiring Member States to sample their recreational fisheries would therefore be maintained but the **definition** of recreational fisheries in the current DCF Regulation should be made more inclusive to ensure the whole recreational fisheries sector is covered.

As is the case currently, the **EU MAP** would further detail the obligations regarding the variables to be collected, the periodicity, the coverage, and the stocks for which it should be collected. On this basis, minimum data on the whole sector may be necessary periodically, to enable an early identification of any problems, as well as more regular (e.g. annual) data collection on catches for important stocks.

5.2.1.2. Impact of fisheries on the marine biological resources and the ecosystem

Background and legal provisions of the DCF

The impacts of fisheries on ecosystems come in many forms, of which the major and most direct impacts are:

- (1) the impact on **target resources**, reducing abundance, spawning potential and other population parameters such as age, size structure, sex ratio etc);

- (2) the impact on other species that are associated with the target species, such as other commercial fish that co-exist with the target species, leading to **mixed fisheries** (e.g. sole and plaice);
- (3) the impacts on unwanted specimens of commercial species (e.g. **juveniles or undersized fish**) which may be caught, and discarded, in considerable volumes;
- (4) there are also unwanted catches of non-commercial, "**protected**" species (e.g. birds, marine mammals, turtles) which tend to be caught incidentally and infrequently;
- (5) there are indirect impacts on non-target species that are dependent on the target species, e.g. as predators or prey, creating **knock-on effects in the foodwebs** and species composition.
- (6) there are also **alterations of habitats**, most notably by destroying and disturbing bottom topography and the associated habitats (e.g. seagrass and algal beds, coral reefs) and benthic communities that live in or on the seabed e.g. through the "ploughing" effect of dredges and trawls.

The Marine Strategy Framework Directive (MSFD) contains 11 Descriptors to be considered when evaluating the state of a Member States' marine waters (see **Annex V**). Descriptor 3 covers the state of commercial fisheries (Impacts 1-3 above). Descriptor 1 covers biodiversity, including protected species (Impact 4 above). Descriptor 4 covers foodwebs (Impact 5 above) whilst Descriptors 1 and 3 are related in part to the state of habitats (Impact 6 above).

The **current DCF** has focused on providing data to assess the impacts of fisheries on commercial fisheries species (the resource), covering both targeted catches and by-catches (**impacts 1-3** above). The current DCF also provides data on where fishing activities take place and with what gear, which contributes to determining the fisheries impacts on seabed habitat (**impact 6**). The current EU Multiannual Programme also includes a list of indicators to measure the effects of fisheries on the marine ecosystem (Appendix XIII). However, since the adoption of the current DCF and EU Multiannual programme, more detailed descriptors and environmental indicators have been developed in the framework of the MSFD.

Regarding **incidental catches of protected species (impact 4)**, there are no binding obligations in the current DCF for Member States to collect such data, as the DCF only covers fisheries species (fish and certain invertebrates). This is at odds with the fact that Member States are required, under several **other EU instruments (e.g. the Birds Directive⁵⁴, Cetacean Regulation⁵⁵, Habitats Directive⁵⁶)**, to sample and report on incidental catches of certain protected species, including marine mammals, birds and marine turtles.

Regarding **knock-on effects in the foodwebs (impact 5)**, analysing stomach contents (who eats whom) is one of the key method to identify these effects. Stomach content data is also beginning to be included in **multi-species stock assessment**, which will increasingly be used under the CFP's requirements to carry out ecosystem-based management of fisheries. The current DCF does not contain any requirements for Member States to collect data on stomach

⁵⁴ **Directive 2009/147/EC** of the European Parliament and of the Council of 30 November 2009 on the conservation of wild birds.

⁵⁵ **Council Regulation (EC) No 812/2004** of 26.4.2004 laying down measures concerning incidental catches of cetaceans in fisheries and amending Regulation (EC) No 88/98.

⁵⁶ **Council Directive 92/43/EEC** of 21 May 1992 on the conservation of natural habitats and of wild fauna and flora.

contents, but some Member States have nevertheless collected stomach content data for some species through their DCF funded research surveys at sea.

Regarding the **impacts of fisheries on habitats (impact 6)**, and in particular on the sea bed, data on the distribution of fishing activity, its intensity and the type of gear involved (i.e. the fishing pressure) are already routinely collected under the DCF (through VMS and logbook data and effort data)⁵⁷. With the knowledge on the seabed composition and of the type of fishing taking place there (e.g. trawling on a coral reef habitat), one can deduce what impact the fishing gear is having in order to take appropriate management decisions (e.g. limiting certain type of gear uses in certain sensitive areas). **Deep-sea seabed organisms** are particularly vulnerable to the impacts of fisheries as they occur in low-energy environments and are therefore slow growing, taking longer to regenerate after an interaction with fishing gear. For this reason, specific monitoring measures have been introduced for these deep-sea organisms e.g. in the Northwest Atlantic Fisheries Organization (NAFO)⁵⁸. The Commission's proposal for a deep sea access regime⁵⁹ also includes specific data collection requirements on sensitive seabed species, for this vulnerable marine ecosystem. Under this proposal, Member States should identify and document the weight of any stony coral, soft coral, sponge or other organism belonging to the same ecosystem taken on board by the vessel's gear. There will be a need to ensure alignment between the needs of the proposal for a new DCF Regulation and the needs and the Deep sea access regime proposal, as regards the data collection provisions referred to in article 19 and Annex II of the latter.

Table 5: Needs the DCF should address: Provide reliable data on ecosystem impacts of EU fisheries to enable ecosystem assessments and to contribute to the MSFD

Problems identified	Objectives of revision	Options for addressing problem	Proposed solution
Insufficient data on some ecosystems impacts of EU fisheries to enable ecosystem assessments	Ensure DCF provides more data on ecosystem impacts of EU fisheries, namely:	-	-

⁵⁷ And the current EU MAP requires Member States to calculate the extent of sea bed area not impacted by fishing gear, as one of the environmental indicators in Appendix XIII.

⁵⁸ <http://archive.nafo.int/open/fc/2013/fcdoc13-01.pdf>

⁵⁹ **Proposal for a Regulation of the European Parliament and of the Council** establishing specific conditions to fishing for deep-sea stocks in the North-East Atlantic and provisions for fishing in international waters of the North-East Atlantic and repealing Regulation (EC) No 2347/2002 (COM(2012) 371 final of 19.7.2012).

Problems identified	Objectives of revision	Options for addressing problem	Proposed solution
	Data on by-catch of non-target species	<p>Include explicit reference to this new area of data collection in the DCF regulation.</p> <p>In addition,</p> <ol style="list-style-type: none"> 1. Include detailed requirements in the EU MAP regarding what species and variables should be sampled and how this should be done. 2. Include detailed requirements in the EU MAP regarding what species and variables should be sampled but let RCGs determine how this should be done. 3. RCGs to determine the most appropriate sampling approach for their region. 	<p>Include explicit reference to this new area of data collection in the DCF regulation.</p> <p>In addition,</p> <p>RCGs to agree on the most appropriate sampling approach for their region.</p>
	Data on predator-prey interactions (foodwebs), i.e. stomach-content data for food-chain analysis	<p>Include explicit reference to this new area of data collection in the DCF Regulation.</p> <p>In addition,</p> <ol style="list-style-type: none"> 1. Collect data on stomach content as part of routine sampling (species to be determined by RCGs). 2. Collect data on stomach content as part of routine sampling (species to be listed in the EU-MAP). 3. Data collection on stomach content through dedicated projects. 	<p>Include explicit reference to this new area of data collection in the DCF Regulation.</p> <p>In addition,</p> <p>Member States to collect data on stomach content as part of routine sampling on selected species listed in the EU MAP.</p>

Problems identified	Objectives of revision	Options for addressing problem	Proposed solution
	Data on impacts of fisheries on habitats	<p>Include explicit reference to this new area of data collection in the DCF Regulation.</p> <p>In addition,</p> <ol style="list-style-type: none"> 1. Regular data collection on fishing pressure (VMS & gear type) included in EU MAP 2. Dedicated research projects on specific impacts on fisheries on different seabed types and organisms (under EMFF or other instruments) 3. List specific seabed organisms in the EU MAP that Member States should monitor when they are caught by fisheries at a minimum those from existing international or EU obligations). 4. Let RCGs decide on which seabed organisms should be monitored when they are caught by fisheries. 	<p>Include explicit reference to this new area of data collection in the DCF Regulation.</p> <p>In addition,</p> <p>Data collection on fishing pressure (VMS & gear type) included in EU MAP</p> <ol style="list-style-type: none"> 2. Dedicated research projects on specific impacts on fisheries on different seabed types and organisms (under EMFF or other instruments) 3. List specific seabed organisms in the EU MAP that Member States should monitor when they are caught by fisheries (at a minimum those from existing international or EU obligations).

Changes to the DCF

One of the principles of the CFP Regulation (Article 2) is that it "*shall implement the ecosystem-based approach to fisheries management so as to ensure that negative impacts of fishing activities on the marine ecosystem are minimised, and shall endeavour to ensure that aquaculture and fisheries activities avoid the degradation of the marine environment.*". Furthermore, the CFP should also "*be coherent with the Union environmental legislation, in particular with the objective of achieving a good environmental status by 2020*" in other words, with the objectives of the MSFD. Regarding data collection (Article 25), the CFP Regulation requires that Member States collect and provide to end-users data that shall enable assessing the level of fishing and the impact that fishing activities have on the marine biological resources and on the marine ecosystems.

In this context, the current **DCF does not provide sufficient data on some ecosystem impacts** of fisheries, that is incidental catches of protected species (birds, marine mammals, turtles etc. - impact 4 above), effects on foodwebs (predator-prey relations), typically measured through stomach content analysis (impact 5) and only contributes some of the required data on the impact of fishing gear on the seabed habitats, namely data on fishing pressure (impact 6).

On this basis, the **scope of the DCF should be amended** to reflect the CFP's new emphasis on ecosystem impacts of fisheries. Whilst DCF core business remains data collection on

fishing activity, there is scope for maximising the synergies between the legislative frameworks by aligning the obligations Member States have to collect certain fisheries-related environmental data and to improve the quality and coverage of the data collected. Additional data on the three ecosystem impacts above could be collected, at minimal additional costs (see **Annex X**), through existing or modified DCF mechanisms such as fisheries research surveys at sea or sampling of commercial vessels' activities. The revised DCF could therefore contribute additional required information relating to **fisheries impacts on the ecosystem**, thereby enhancing synergies with MSFD requirements whilst following the most cost-effective solutions.

Specifically, the relevant provisions of the **DCF Regulation** relating to the contents of the EU MAP should be further specified to include data collection on **impacts on non-target species** including species protected under international or EU legislation, **impacts of fishing gear on marine habitats** and **impacts on food webs**.

Also, inclusion of data collection provisions in the DCF on **by-catch of non-target species, in particular species protected under international or EU law** – a dedicated data collection instrument – should improve the quality and harmonization of the data collected and would include standardized procedures to ensure data are provided to the data users that need them.

The EU MAP would detail these provisions further (see **Annex X** for more details).

5.2.1.3. Socio-economic data on the catch sector

Regarding the catch sector, the current DCF contains provisions requiring Member States to collect economic data on the EU fleet, to enable the assessment of the economic performance of the sector. No other EU legislation requires the collection of such data, and the **DCF Regulation would therefore continue to be the basis for collection of these data**. The exact data to be collected would be detailed further in the future EU MAP.

5.2.1.4. Assessing the impacts of the landing obligation

Background and legal provisions of the DCF

The CFP Regulation introduced an obligation for Member States to land all catches of species which are subject to catch limits and, in the Mediterranean, also catches of species which are subject to size limitations, caught during fishing activities in Union waters or by Union fishing vessels outside Union waters in waters not subject to third countries' sovereignty or jurisdiction, in the fisheries and geographical areas listed in that regulation. However, the CFP Regulation contains a number of exemptions namely: i) species not covered by catch limits; ii) species where high survivability can be demonstrated; iii) prohibited species; iv) limited volumes of permissible discards which can be triggered under certain conditions (the so called "de minimis exemptions"), and v) inter-species and inter-annual quota flexibility mechanisms. Therefore, in practice, in most if not all fisheries, some discarding will still be authorized.

There are two questions arising from the inclusion of a landing obligation in the CFP Regulation that the DCF should address:

- i. How does the landing obligation affect the **sampling of catches, including discards**?
- ii. Do we have the necessary data to **evaluate the impacts** of the landing obligation?

Regarding the first question, under the current DCF, **discards are sampled through at-sea scientific monitoring** of commercial catches (by scientific observers) (Article 11.1). This at sea monitoring covers both discards and retained catches. For retained catches (that are landed), biological data are also collected in harbours.

This collection of data on catches, including discards, for scientific purposes is separate from the collection of data on catches for control purposes, under the Control Regulation. Data are collected by different bodies, under different legislations and for different purposes. This distinction between scientific observers and control inspectors is essential as they do not pursue the same goals; the former are operating in the context of sampling programmes, for which collaboration of the fishing sector is essential; the latter is conducted to check compliance of individual vessels with EU and national legislation on fisheries.

Despite this difference in purposes, and although under the DCF, scientific observers must be given access by captains to fishing vessels to carry out their work (Article 11.3), in practice, access relies to a large extent on the good-will of captains and in many Member States, scientific observers have experienced problems gaining access to vessels for their DCF work. Under the landing obligation, there is therefore widespread concern amongst the scientists that access to vessels may become even more difficult, as scientific observers may be perceived by fishermen to have also a control function, in an environment where discarding is, for the most part, illegal. Where scientists are granted access to vessels, there is a concern that the fishing behaviour/areas visited etc. may be changed to avoid areas with high by-catch and will result in biased results.

However, scientific observer at sea programmes will need to continue, as some sampling cannot take place in harbours, namely (authorized) discards, discards of incidental by-catch such as birds and marine mammals, sampling of fish that will be frozen and/or processed on board, and sampling in long-distance fisheries.

It will therefore be important to ensure that the DCF Regulation maintains provisions on access for scientific observers to vessels. The most appropriate way to carry out scientific data collection on catches including discards (observers at sea, CCTV etc.) and how to address the issue of potential bias, are issues that will require further expert work, such as is already ongoing within STECF.

As regards evaluating the impacts of the landing obligation, the EU and its Member States should ensure they have the necessary data, in a few years' time, to evaluate what the **impacts of the landing obligation** have been on the state of exploited marine biological resources and on the economic performance of the fleets. Possible impacts include for example, development of more selective gears to reduce by-catch, an improvement of the fish stocks in the EU due to improved selectivity and reduced overall catches, development of new markets to make use of the unwanted catches for non-human consumption⁶⁰, changes in profitability of certain sectors/fisheries, or negative impacts on some stocks due to removal of a food source (the discarded fish).

Changes to the DCF

In light of the current uncertainty regarding the impacts of the landing obligation on catch sampling under the DCF, and in particular on the reliability of data collected through observer schemes, the revised DCF Regulation should include an **obligation for Member States to carry out biological sampling on all stocks targeted or by-caught by EU vessels**, including on the discarded fraction of the catches, but without specifying the method for the data collection (i.e. whether it is through observers at sea or CCTV or other methods).

⁶⁰ the CFP Regulation, for species subject to the landing obligation, the use of catches of species below the minimum conservation reference size shall be restricted to purposes other than direct human consumption, including fish meal, fish oil, pet food, food additives, pharmaceuticals and cosmetics (Article 15 Under)

The **EU MAP** may detail this **general obligation** further, and may specify the methods to be used when scientific discussions have advanced enough and if they have concluded that the method should be specified at EU level rather than left up to Member States or regional groupings.

The scope of the current DCF does not refer to the need to collect data to support **assessment of the impacts of EU policies relating to fisheries**, such as the landing obligation. As the instruments providing data for implementation of the CFP, the DCF should, however, enable such assessments of policy measures stemming from the CFP. The future DCF Regulation would therefore include, as part of the criteria for determining what data to include in the EU MAP, the need to support impact assessments of policy measures. This would enable future inclusion of additional data under the EU MAP, if required, to evaluate for example the impacts of the landing obligation.

Regarding ensuring **access to vessels for scientific observers**, the existing legal provisions in the **DCF Regulation** requiring captains to grant access to scientific observers are appropriate: the problems observed in the past regarding this aspects of the DCF relate not to the legal framework, but to a lack of compliance by captains with these provisions, and insufficient follow-up by Member States to ensure the provisions are complied with. The DCF Regulation would therefore also include a provision enabling the Commission to adopt an implementing act to establish detailed provisions to ensure a harmonised and effective implementation of this provision.

The current clear separation between scientific observers and control observers should be maintained. The problems that have arisen in the past should be addressed through improved enforcement by Member States. Therefore, the Commission will **work closely with Member States** to ensure they enforce this provision and can share their experiences to increase compliance with this requirement.

5.2.2. *Data on fishing activity*

Background and legal provisions of the DCF

Data on fishing activity (e.g. capacity, effort, landings and catches) are required for analysis of both biological and economic data. In the current legislative framework, such data are collected and made available under **several pieces of EU legislation**: primarily the Control Regulation, but also the Fishing Authorisations Regulation, Fleet Register Regulation, and several Statistical Regulations catch statistics and on landings of fisheries products (see **Table 6**).

In addition, the DCF contains provisions on use of data on vessels' activity coming from VMS, and on data allowing the estimation of total volumes of catches, including discards, including where relevant data on catches from recreational fisheries (Article 15). The exact data relating to fishing activity data are listed in Appendix VIII of the EU MAP, and include for example weight of landings per species.

Table 6: Overview of EU legislations containing provisions on fishing activity data

Legislation	Data	Tools/Data sources
Control Regulation ⁶¹	Fishing effort & catches of EU vessels in EU waters. Landings of EU vessels in EU & external waters.	Logbooks, landing declarations, sales notes and VMS.
Commission Fleet Register Regulation ⁶²	Capacity of EU vessels	EU fleet register
Fishing Authorisations Regulation ⁶³	Fishing effort & catches of EU vessels in external waters. Catches of non-EU vessels in EU waters.	EU fishing authorisation information system
Statistical Regulations on catch statistics and on landings of fisheries products ⁶⁴	Landing and catches	Data are assembled and reported under these legislations, and disseminated by Eurostat.

As regards **articulation between DCF data and data stemming from the Control Regulation**, the DCF concerns the fishing activity data collected under the Control Regulation insofar as it requires that these data be transmitted to end-users upon request. Hence, the obligations on collection are laid down in Control Regulation, whilst the obligations on transmission to end-users are set out in the DCF Regulation.

However, some **discrepancies** exist. Under the Control Regulation, Member States are not required to fill out electronic logbook for some segments (less than 12 meters) of the fleet, for catches below a certain threshold (50 kg) and for recreational fisheries. They are required to fill out paper logbooks for segments between 10-12 meters, and to keep sales notes (from

⁶¹ **Council Regulation (EU) No 1224/2009** of 20 November 2009 establishing a Community control system for ensuring compliance with the rules of the common fisheries policy, amending Regulations (EC) No 847/96, (EC) No 2371/2002, (EC) No 811/2004, (EC) No 768/2005, (EC) No 2115/2005, (EC) No 2166/2005, (EC) No 388/2006, (EC) No 509/2007, (EC) No 676/2007, (EC) No 1098/2007, (EC) No 1300/2008, (EC) No 1342/2008 and repealing Regulations (EEC) No 2847/93, (EC) No 1627/94 and (EC) No 1966/2006

⁶² **Commission Regulation (EC) No 26/2004** of 30 December 2003 on the Community fishing fleet register

⁶³ **Council Regulation (EC) No 1006/2008** of 29 September 2008, concerning authorisations for fishing activities of Community fishing vessels outside Community waters and the access of third country vessels to Community waters, amending Regulation (EEC) No 2847/93 and (EC) No 1627/94 and repealing Regulation (EC) No 3317/94

⁶⁴ **Regulation (EC) No 1921/2006** of the European Parliament and of the Council of 18 December 2006 on the submission of statistical data on landings of fishery products in Member States and repealing Council Regulation (EEC) No 1382/91

Regulation (EC) No 216/2009 of the European Parliament and of the Council of 11 March 2009 on the submission of nominal catch statistics by Member States fishing in certain areas other than those of the North Atlantic (recast)

Regulation (EC) No 217/2009 of the European Parliament and of the Council of 11 March 2009 on the submission of catch and activity statistics by Member States fishing in the north-west Atlantic (recast)

Regulation (EC) No 218/2009 of the European Parliament and of the Council of 11 March 2009 on the submission of nominal catch statistics by Member States fishing in the north-east Atlantic (recast)

which information on catches can be derived) for smaller vessels but there are no obligations to record catches below 50kg. However, data on catches from the whole sector, including all segments, are needed for scientific purposes. Therefore the Control Regulation does not provide data on all catches (i.e. below 50kg) and for the rest of the catches, due to the complication of accessing the information in these various data sources (electronic and paper logbooks and sales notes), some Member States have set up sampling programmes under the DCF to collect data on the smaller segments (this is particularly the case in the Mediterranean where there are many small-scale vessels, not covered by the logbook obligations). In addition, for scientific purposes, some catch data are needed at a lower aggregation level (e.g. on a haul by haul basis) compared to what is required under the Control Regulation, where catch and discards by geographical area must be recorded (at least) once a day but not by haul.

Apart from discrepancies between different processes of data collection, there is also **duplication of storage and transmission**. In response to annual data calls made by Commission services under the DCF⁶⁵, Member States are required to send catch data to the Commission (JRC) for scientific purposes, while they are required to send to the Commission (DG MARE) the same data on a monthly or bimonthly basis for control purposes and to the Commission (Eurostat) their catch data for statistical purposes. While for the purposes of the Control Regulation, data on fishing activity stored in an EU-wide database are only accessible to Member States control authorities, some of the data on fishing activity for scientific purposes are also stored in DCF regional data bases, in a JRC database and for statistical purposes some data are stored in Eurostat databases.

Changes to the DCF

Several updates of the legislative framework and to the current data management procedures are required to reduce discrepancies and ensure alignment of legal requirements and data collection and transmission processes, with a view to increase transparency and reliability of data, and to reduce administrative burden on Member States.

Specifically, regarding the **relation between Control and DCF Regulation**, until the Control Regulation provides the full data sets that are required by scientific end-users, additional data to that collected under the Control Regulation may need to continue to be collected on the basis of the DCF. The DCF Regulation would, however, specify that Member States should only collect fishing activity data under the DCF where this is not already provided for under existing EU legislation i.e. under the Control Regulation.

Adjustments could be made in the provisions of the Control Regulation regarding what should be recorded in the logbooks, in order to fill the above data gaps, but this may require slight modification of the Control Regulation or its implementing provisions.

Adjustments may also need to be made to ensure the alignment of the DCF Regulation and the Fishing Authorisations Regulation.

The **EU MAP** would specify the fishing activity data to be collected in addition to those collected under the Control, Statistical, Fishing Authorisations or Fleet Register regulations.

Beyond the legislative changes, the Commission is exploring ways of streamlining the data transmission and storage for fishing activity data. This would be achieved, in part, through

⁶⁵ These data calls concern the economic performance of the fisheries, aquaculture and processing sector, fishing effort, and biological data on Mediterranean and Black Sea stocks.

alignment first between provisions on catch reporting stemming from the Control and statistical regulations. Solutions lie at several levels and can be implemented in several steps. First, the aim is to align the definitions and the IT systems in use for the exchange of information between the Commission services and Member States for control and statistical purposes. Then, dissemination of statistics by Eurostat will be based on the data collected under the Control Regulation. This would require an amendment of the statistical regulation on catches. Once this alignment is achieved, the same data could also be used for the purpose of scientific advice (ensuring that personal data protection issues are addressed - see Chapter 5.5) and there would no longer be a need for the Member States to make these data available to end-users through a separate, DCF channel.

5.2.3. *Data on the aquaculture and processing sectors*

The current DCF contains provisions requiring Member States to collect and transmit to end-users socio-economic data on the aquaculture and processing sectors (Article 3). The aim of this particular data collection is to gather data explaining price formation and other data which may facilitate an assessment of the economic situation of the aquaculture and the processing industry, and of employment trends in these sectors. The current EU MAP specifies the exact socio-economic data that all Member States must collect on these two sectors. The current DCF does not cover data on the environmental impact, or sustainability, of the aquaculture sector.

5.2.3.1. Socio-economic data on aquaculture and data on the sustainability of the sector

Background and legal provisions of the DCF

For aquaculture, the current DCF covers only marine species, including eels and salmon, farmed within the Member States and EU waters. The collection of socio-economic data on aquaculture of **freshwater** species is therefore not mandatory. Nevertheless, given the usefulness of such data, a third of the Member States collect socio-economic data on their whole aquaculture sector, that is, including for freshwater species⁶⁶. The CFP puts a strong emphasis on developing and investing in EU aquaculture, yet the absence of EU-wide data on freshwater aquaculture hinders an EU-wide assessment of this sector, from an economic and a social point of view, as well as comprehensive national analysis of the sector.

The CFP Regulation stresses the importance of the sustainable development of aquaculture in Europe, and the EMFF will provide EU funding for aquaculture. Regarding the three pillars of sustainability (economic, environmental and social), some economic and social data are already covered by the DCF but additional data may need to be collected regarding its environmental aspects. Indeed, regarding the **environmental impacts** of aquaculture, no data are currently included in the DCF and no EU-wide information on the environmental impacts of aquaculture is readily available to the EU and Member States. Such data is needed in order to better identify where environmental impacts are higher or lower, and therefore better assess what should be the most relevant policy decisions to support a sustainable development of aquaculture.

For example, the following types of data are currently not available at EU level:

- What goes in to the aquaculture system: feed, nutrients, medicine

⁶⁶ http://stecf.jrc.ec.europa.eu/documents/43805/622206/2013-12_STECF+13-29+-+Aquaculture+economics_JRC86671.pdf

- What comes out of the system: Nitrates, phosphates
- Losses: mortality, escapement of fish/organisms
- Food safety: number of incidents reported in the rapid alert system for food and feed (RASFF)
- Food quality: Production of organic aquaculture; production under other food quality labels.

Information about these impacts of aquaculture can be obtained in a variety of ways: either the data on the impacts can be collected (e.g. by measuring the phosphates emitted by every aquaculture facility) or the impacts can be estimated (e.g. by taking a value for the average level of phosphate coming out of an aquaculture plant, and extrapolating it to the whole sector). Currently, European Performance Indicators for Aquaculture⁶⁷ indicators exist at EU level, based on data taken from the literature rather than a comprehensive data collection exercise.

Several of the variables listed above (medicines used, mortalities and losses), are already recorded by aquaculture facilities under two EU Directives: Directive 2011/82/EC⁶⁸ and Directive 2006/88/EC⁶⁹. However, these Directives contain no obligation regarding transmission of these data to the authorities or to any user and they are therefore not currently accessible for Member State or EU-wide analysis.

⁶⁷ <http://publications.jrc.ec.europa.eu/repository/handle/111111111/27600>.

⁶⁸ **Directive 2001/82/EC of the European Parliament and of the Council** of 6 November 2001 on the Community code relating to veterinary medicinal products.

⁶⁹ **Council Directive 2006/88/EC of 24 October 2006** on animal health requirements for aquaculture animals and products thereof, and on the prevention and control of certain diseases in aquatic animals

Textbox 3 - Resource implications for collection of socio-economic data on freshwater aquaculture

In addition to data collection under the statistical regulation⁷⁰, the DCF socio-economic data on freshwater aquaculture are already collected fully or partly by 9 Member States⁷¹ whilst in 4 Member States the freshwater aquaculture sector is (close to) non-existent⁷². For others, however, it would come as an addition to the current data collection under Statistical legislation. The situation would be twofold:

- For coastal Member States: as they already have a DCF data collection established, covering freshwater aquaculture would require a simple extension of their existing programme, once they have identified the freshwater aquaculture companies.
- For land-locked Member States: in so far they only collected data under Statistical legislation, this may require a preparatory phase to design and prepare the study, questionnaires, interviews etc. needed to collect the additional "DCF" (i.e. socio-economic) data.

The cost of this data collection depends primarily on the number of enterprises to be surveyed. This varies hugely between Member States, from under 10 to over 800. Additional staff time will be required for setting up or expanding the existing aquaculture DCF programme to include the freshwater sector, as well as for the additional data collection, processing, and analysis.

Using the individual Member States' average staff rates for scientists⁷³, if one presumes that all MS would require: i) 10 days for the preparatory phase, setting up the programme (only in the first year), ii) 1.5 days per freshwater company per year for data collection and processing, and iii) between 5 and 15 days per year for data analysis depending on the size of the sector, it can be theoretically estimated that the cost of a one-off setting up would be, as a **maximum**, between 350€ and 5000 € depending on the Member State (equivalent to around 65 000 € at EU level). This would mean annual costs of between 1500 € and 380 000 € per Member State (equivalent to around 1 300 000 € at EU level).

However, this is an overestimation given that in half the Member States, freshwater data collection is either already carried out, or the sector is (virtually) non-existent. The estimate above is also based on exhaustive sampling of the sector (i.e. a census of all enterprises) whereas in fact Member States may sample only a sub-section of their sector, which would substantially reduce the costs.

80% of these costs can be covered by EU co-financing under the EMFF.

Changes to the DCF

In light of the new needs of the CFP regarding data on the whole aquaculture sector, the scope of **DCF Regulation** should be revised so that obligations to collect socio-economic data **cover also freshwater aquaculture**. The relevant provisions of the DCF Regulation should also be further specified to establish that information should be gathered to **enable the assessment of the environmental impacts** of aquaculture.

⁷⁰ See section 5.2.3.2.

⁷¹ Denmark, Finland, France (partly), Ireland, Italy, Portugal, Romania, Spain (partly) and Sweden.
http://stecf.jrc.ec.europa.eu/documents/43805/622206/2013-12_STECF+13-29+-+Aquaculture+economics_JRC86671.pdf

⁷² Bulgaria, Cyprus, Malta, Luxembourg http://stecf.jrc.ec.europa.eu/documents/43805/622206/2013-12_STECF+13-29+-+Aquaculture+economics_JRC86671.pdf

⁷³ Based on average staff costs in the EU Member States' financial forms for their 2011 data collection programmes

Member States would only be obliged to collect data on environmental impacts of aquaculture data on the basis of the DCF where there is no existing obligation to collect such data under other EU legislation (such as the EU Directives on veterinary medicinal products and on animal health, mentioned above). Such additional data would be included in the EU MAP.

The DCF provisions on availability of data, though, would apply to all data, whether collected (or recorded) under the DCF or other EU legislation. In the case of data on the environmental impacts of aquaculture, this would enable the data on medicines used, or mortalities and losses, currently recorded under existing EU legislation, to be made available at EU level for analysis. If the estimated costs of this expansion of the EU MAP are considered too high (see Textbox 3), the revised **EU MAP** may include **thresholds** below which socio-economic or environmental impact data need not be collected e.g. on aquaculture plants with a small production or income, or for Member States where aquaculture is negligible in economic term. In addition, the EU MAP could distinguish between **mandatory** data to be collected and **optional** data, and also between data to be collected **annually** and those that can be collected **less frequently**, as in some cases, there is little inter-annual changes in some socio-economic data (e.g. gender balance in employment).

5.2.3.2. Overlaps with EU legislation on Statistical Data on aquaculture and the processing sector

A key objective of the revision of the DCF is to **eliminate redundancies** between regulatory frameworks following the principle "one collection point, several uses", in order to avoid multiple reporting, achieve synergies and reduce administrative burdens in the future. This applies both for socio-economic data on aquaculture, as well as data on the environmental impacts of aquaculture.

The ex-post evaluation of the DCF⁷⁴ identified some major **duplications and overlaps** between the DCF on the one hand (that covers socio-economic data collection on the aquaculture and processing sectors) and, on the other hand, the EU statistical legislation on aquaculture⁷⁵ and EU legislation on the Structural Business Statistics⁷⁶ which cover the processing sector (see **Annex III**).

In the case of aquaculture, in some cases there are wide discrepancies among the Member States in the way they collect and process the data under these different legal frameworks. These discrepancies can be explained by the fact that the two legal frameworks cover different populations and the data are used for different purposes. Under Statistical legislation, data are collected with the aim of estimating primary production entering the market for human consumption, comparable with agricultural statistics. Under the DCF, data are collected to enable analysis of the economic performance of the companies involved in aquaculture (see **Annex XI** for further details and also the report of the STECF⁷⁷).

⁷⁴ http://ec.europa.eu/fisheries/documentation/studies/retrospective-and-prospective-evaluation-on-common-fisheries-policy_en.pdf.

⁷⁵ **Regulation (EC) 762/2008 of the European Parliament and of the Council** of 9 July 2008, on the submission by Member States of statistics on aquaculture and repealing Council Regulation (EC) 788/96

⁷⁶ **Regulation (EC) No 295/2008 of the European Parliament and of the Council** of 11 March 2008 concerning structural business statistics

⁷⁷ Report of the STECF EWG14-24 Preparations for future DCF
http://stecf.jrc.ec.europa.eu/documents/43805/854928/2014-12_STECF+14-24+Preparations+for+future+DC_JRC93103.pdf

In a report by the European Court of Auditors⁷⁸, this apparent duplication of data collection in **aquaculture** was criticised, in particular because of the differences in the resulting figures and statistics. In response to this report, the Commission has committed to improve the comparability, accuracy and completeness of both datasets in the period 2015-2020 starting with the revision of the DCF Regulation.

Concerning the fish **processing** industry, the Structural Business Statistics cover industry, construction, trade and service all EU Member States and describe the structure, conduct and performance of businesses across the EU. Under this Regulation, Member States must collect socio-economic data on, amongst other, the processing sector. There is substantial overlap between these data and the socio-economic data that Member States must provide under the DCF (as detailed in Appendix XII of the EU MAP): the DCF requires the collection of 17 indicators, of which 11 are identical or closely related to those covered by the Structural Business Statistics (see also **Annex III**).

The socio-economic data on the processing sector covered by the DCF can currently not be linked to the fisheries or aquaculture sector or to any region due to the absence of data on the origin of the raw material used in the processing sector. STECF has noted that without being able to analyse the linkages between the catching and processing sector, the value added of the data collection in the DCF is questionable compared to those collected under the Structural Business Statistics.

All in all, this situation leads to a very sub-optimal use of public resources.

Table 7: Needs the DCF should address: To ensure single collection but multiple use of reliable data on aquaculture and processing.

Problems identified	Objectives of revision	Options for addressing problem	Proposed solution
Overlaps and duplications in data collection between statistical legislation and DCF concerning aquaculture and processing industry	Move to single data collection and multiple use of data	<p>1. Statistical regulations continue to set out basic data collection obligations for aquaculture and processing industry, DCF EU MAP only requires additional data</p> <p>2. DCF continues to set out data collection obligations for aquaculture and processing, statistical regulations are amended and/or repealed to delete any data collection requirements on aquaculture and processing</p>	<p>Statistical regulations continue to set out basic data collection obligations for aquaculture and processing industry, DCF only requires additional data</p> <p>Close coordination on data quality and detailed description of the data sources and procedures are carried out.</p> <p>Amendment of the Statistical regulations if further alignment is necessary for the purposes of the CFP.</p>

⁷⁸ European Court of Auditors (2014) Special Report No 10/2014 "The effectiveness of EFF support for aquaculture" http://www.eca.europa.eu/Lists/ECADocuments/SR14_10/QJAB14010ENC.pdf

Changes to the DCF

The statistical legislative framework would serve as the primary basis for collection and management of basic data on aquaculture and processing industry. Similarly to the general principle set out in section 5.2.2., the **DCF Regulation should specify that the EU MAP would contain only those data on the aquaculture and processing sectors that are not already covered** by the EU statistical legislation on aquaculture⁷⁹ and the EU legislation on the Structural Business Statistics⁸⁰ (for the processing sector).

The **Statistical regulation on aquaculture** may be revised if this is necessary to enable the data collected under that framework to serve both the purposes of producing EU-wide statistics on aquaculture production, and for the purposes of the CFP. This alignment should be done with the intention to guarantee at least the same level of quality of the data as the one currently collected and disseminated by Eurostat.

At this stage it does not seem necessary to revise the **Structural Business Statistics**, as this legislation is very detailed, and the provisions on variables and formats apply to all the sectors covered by this legislation (of which processing is only one, very small sector).

Any **additional data** would be included in the **EU MAP** based on the general criteria outlined in the DCF Regulation (end-user need, feasibility, cost etc – see section 5.1), including the periodicity of collection (one-off pilot study; annual bi- or triennial collection), aggregation levels and for which variables collection is mandatory vs optional. The EU Coordination Group would recommend the methodological aspects that Member States should follow regarding how these data should be collected (e.g. sampling strategies, precision levels). The EU Coordination Group should involve National Statistical Institutes and should take into account the European Statistics Code of Practice and the Quality Assurance Framework of the European Statistical System where relevant.

In addition, **close coordination** between Commission services on data quality and detailed description of the data sources and procedures will be carried out, and the same increased coordination within Member States between statistical offices and bodies involved in the DCF programme will be fostered.

5.3. How data should be collected

5.3.1.1. Provisions on methodological issues

Background and legal provisions of the DCF

DCF data are obtained in a **variety of ways**⁸¹: i) at sea through observers on board commercial vessels (fisheries dependent data) or on research surveys (fisheries independent data) ii)

⁷⁹ **Regulation (EC) 762/2008 of the European Parliament and of the Council** of 9 July 2008, on the submission by Member States of statistics on aquaculture and repealing Council Regulation (EC) 788/96

⁸⁰ **Regulation (EC) No 295/2008 of the European Parliament and of the Council** of 11 March 2008 concerning structural business statistics

⁸¹ For a more detailed overview of methods used to collect biological data and how they are used in stock assessments, see section 1.2 of the 2013 report Data deficient Fisheries in EU waters of the European Parliament's Directorate General for Internal Policies, Policy Department B [http://www.europarl.europa.eu/RegData/etudes/etudes/join/2013/495865/IPOL-PECH_ET\(2013\)495865_EN.pdf](http://www.europarl.europa.eu/RegData/etudes/etudes/join/2013/495865/IPOL-PECH_ET(2013)495865_EN.pdf)

through sampling in harbours, iii) through questionnaires or interviews (mainly for socio-economic data); or iv) by re-using data collected under other legislations (Articles 9, 11, 12 and 15).

When sampling commercial fisheries, Member States must do this **concurrently**, which means that all species covered by the DCF must be sampled simultaneously in a vessel's catches or landings. The sampling unit is the **metier**⁸² and a threshold is defined to exclude the smaller metiers from the sampling requirements of the DCF (only top 90% should be sampled). It is the **Member State on whose territory the first sale takes place** who is responsible for ensuring the biological sampling takes place.

As described in the Introduction, as well as specifying **what** should be sampled (species/stocks, variables) and how often (frequency), the current EU MAP (in Chapters II, III, IV and V and Appendix VI, VII, X, XII & XIII) contains detailed and very complex provisions regarding **how** the sampling should be performed (precision levels, sampling intensities, sampling strategy, schemes for concurrent sampling, disaggregation level, guidelines to be followed, thresholds and exemption rules).

Specifying such detailed aspects of data collection at EU level results in both a very complex EU MAP, and an insufficiently flexible system, as every time a change is required, this requires amendment of the EU MAP.

Changes to the DCF

One of the key changes that should take place through the revision of the DCF is that **methodological aspects should no longer be specified in EU legislation**, whether the DCF Regulation or the EU MAP, as is currently the case, but should be left to coordination between Member States in Regional Coordination Groups or through the EU Coordination Group for socio-economic, or other EU-wide issues. The most important methodological aspects (source of the data, the procedures and methods to collect and process data, quality assurance and control frameworks) will then be endorsed by the Commission as part of each Member State's Work plan or as part of regionally agreed work plans. Indeed, this stems from the fact that sampling strategies, intensities, precision levels to be reached may evolve over time with scientific knowledge or know how and setting these at EU level does not allow for sufficient flexibility.

As a result, the provisions of the current DCF Regulation (Article 9) that concern sampling strategies would not be included in the revised DCF, and all the detailed methodological requirements established in the current EU MAP would not be included in the future EU MAP.

Regarding the **metier approach**, used to sample biological data, it has emerged very clearly from consultations that this is not the appropriate unit for establishing sampling plans, even though it may be a useful way in which to present data **after** collection to allow allocation to metiers based on the defined target assemblage and fishing gear characteristics to ensure the continuation of time series data for fisheries based management models (e.g. to allow linking of biological and economic data on the fishing fleet). Therefore, under the future system, where RCGs will be tasked with methodological aspects, Member States would no longer be

⁸² The metier is defined in the EU MAP (Chapter I) as *a group of fishing operations targeting a similar (assemblage of) species, using similar gear, during the same period of the year and/or within the same area and which are characterised by a similar exploitation pattern;*

required to set up their sampling programmes using metiers, but could choose to do so on the basis of stocks.

5.3.1.2. The particular case of research surveys at sea

Background and legal provisions of the DCF

One manner of collecting biological, fisheries independent data is through research surveys at sea. Research surveys provide fisheries independent data which is essential for certain type of fisheries assessments. Research surveys account for 50% of the budgets spent on data collection at EU level, and even more in certain Member States⁸³.

Currently, the DCF Regulation imposes an obligation on Member States to *'carry out research surveys at sea to evaluate the abundance and distribution of stocks, independently of the data provided by commercial fisheries, and to assess the impact of the fishing activity on the environment'* (Article 12), specifying that such a list of mandatory surveys will be established in the EU MAP but only in terms of eligibility for funding of the surveys included in that list, not in terms of Member States' obligations to cover the listed surveys. Such a list, which contains 43 research surveys, is included in Appendix IX of the EU MAP. Should the Commission wish to amend this list, or to authorize Member States to make modifications in the design of the surveys, the Commission is required to first seek advice from the STECF (Article 7 of Commission Reg. (EC) No. 665/2008).

Prior to 2014, under direct management, this list constituted not only a list of obligations on Member States but also a list of research surveys at sea eligible for the EU co-financing under the DCF.

The EU MAP also requires Member States to guarantee within their National Programmes continuity with previous survey designs.

Many of the surveys listed in the EU MAP are internationally-coordinated surveys (e.g. under ICES) that are carried out by several Member States and/or third countries. There are, however, no EU provisions specifying which Member States should contribute to which survey, or how effort should be split between Member States for each survey. This contrasts with provisions on biological data collection for which the EU MAP specifies rules for deciding when a Member State must collect such data.

Experience in implementing the DCF and consultations have revealed that the absence of EU rules on allocation of Member States' tasks with regard to international surveys has resulted in a lack of clarity on who should contribute. Some Member States feel that others are taking advantage of the lack of clear obligations in the DCF to not 'pull their weight' in terms of contribution to survey efforts. There is broad agreement that Member States that fish a particular stock (above a minimum level) should contribute to international surveys that provide data for assessment of those stocks.

Changes to the DCF

Given the crucial importance of fisheries-independent data (i.e. collected during research surveys) and the importance of having long-standing time series with such data to enable a full assessment of fish stocks, the **list of research surveys** that should be carried out by Member States should continue to be determined at the level of the EU. The emphasis of the current DCF regarding research surveys was both on the obligatory nature of the surveys included in the current EU MAP, but also on the fact that (only) these were eligible for EU

⁸³ Based on actual amounts spent by Member States in 2013, taken from costs claims submitted to the European Commission.

co-financing under the DCF's former financial mechanism. As eligibility is now governed by the rules of the EMFF, the provisions on research surveys in the DCF Regulation should only relate to the obligation to carry these out. The DCF Regulation would contain criteria on which basis the list of obligatory surveys in the EU MAP would be established by the Commission. Such criteria, based on those developed by STECF⁸⁴, could be:

- (1) needs according to internationally agreed coordination and harmonisation;
- (2) feedback on management plans, including the monitoring of ecosystem variables;
- (3) needs of the scientific community;
- (4) needs to obtain sufficient coverage of stock area;
- (5) avoidance of duplication between surveys; and
- (6) avoid disruption of history of the survey data.

The DCF Regulation would also contain a provision regarding the **principle to apply task sharing between Member States**. The EU MAP may detail this provision further as necessary, including thresholds of fishing activities for Member States below which they do not have to participate in surveys.

5.4. Ensuring adequate quality of the data

Background and legal provisions of the DCF

Data quality has improved since the DCR (2000) and then the DCF (2008) were established, but it could further improve. The current DCF Regulation contains provisions whereby **Member States must explain** their procedures and methods in their National Programmes (Article 4.3), which are evaluated by the STECF. Member States must also **report** on the quality of the data collected in their Annual Reports (Article 7(2)), which are also evaluated by the STECF. Furthermore, Member States are to **standardize** their methodologies within regions, to follow international quality standards and to estimate accuracy and precision of their data as far as possible (Article 9(3) and 9(4)). **Member States are responsible** for the quality and completeness of the primary data collected under their National Programmes and for the detailed and aggregated data derived therefrom and provided to end-users (Article 14).

The EU MAP currently contains quality targets in the form of a measure of precision (Coefficients of Variations (CVs)) that needs to be met by Member States and on which they should report in their Annual Reports. Compliance of Member States with the DCF provisions on quality are assessed by the STECF through the examination of Annual Reports, based on whether target CV values are achieved by Member States, and through feedback from end-users.

Experience with implementing the DCF has revealed that CV values on their own are not a particularly good measure of quality and that the CV targets specified in the DCF are unrealistic and in practice, often not achieved by Member States. STECF⁸⁵ has recommended that the EU rules no longer include pre-defined quality targets but instead should contain minimum sampling targets (i.e. number of samples to be collected) and that Member States include quality indicators in their Annual Reports so that these can be evaluated by the relevant scientific bodies or data users.

Two other aspects are to be considered if one is to improve quality of DCF data.

⁸⁴ STECF report SGRN10-03: http://stecf.jrc.ec.europa.eu/documents/43805/44904/10-10_SG-RN+10-03+-+Surveys_JRC61965.pdf

⁸⁵ STECF 13-01 report http://stecf.jrc.ec.europa.eu/documents/43805/435014/2013-01_STECF+13-01+-+Review+of+proposed+DCF+2014-2020_JRC79209.pdf

Firstly, **quality assurance** of the data collection and processing is essential and should be provided along with the data themselves.

Consultations, including of the STECF⁸⁶, and experience have revealed that the present system of reporting data quality in DCF programmes is inappropriate. The main reason for this is that the present system only covers part of the data quality aspects, with a strong focus on precision but few requirements to assure representativeness of collected data and to reduce (the risk of) bias. **Quality assurance** needs to be assured for all components (including design and implementation of data collection schemes, data archiving as well as methodologies to derive final estimates).

Furthermore, STECF recommends that the quality evaluation should be through a well-structured **peer-review** process supported by **clear documentation** of all components of the sampling programmes and the sampling outcomes. Quality of a sampling survey programme should be evaluated in relation to two aspects of sampling: i) the ability of the programme to (in principle) deliver data that are fit for purpose, by reviewing the design of the programme against guidelines and standards for best practice; and ii) evaluation of the quality of the data following implementation of the sampling survey, covering each of the two components of accuracy, bias and precision.

Secondly, in the case of biological data, when it comes to shared stocks, information on quality of national data sets is of little use to data users. Instead, they need to know the **quality of the data at stock level**, which, for shared stocks, means aggregating data from several Member States and assessing quality of that aggregated data set.

Changes to the DCF

The provisions in the DCF regarding data quality could be strengthened by 1) improving the design of the sampling programmes based on end-user needs, such that the intrinsic quality will improve, and 2) requiring greater transparency on the methods used by Member States. By contrast, detailed provisions on quality targets should no longer be prescribed at EU level, whether in the DCF Regulation or in the EU MAP. From output led, the EU rules should focus on setting up more efficient processes for quality checks in Member States and across Member States.

Specifically, the DCF Regulation would continue to require Member States to set up a **quality assurance and quality control** framework at national level, to ensure quality of the data. The concrete set up of this process should be explained in the national work plan, thereby improving the transparency on the methods and procedures used in each Member States.

As methodologies evolve over time, the methodologies themselves should not be set in the regulatory framework. Instead, the DCF Regulation would require that Member States coordinate with other Member States when developing their national work plans (which cover also methodologies) and that Member States ensure their work plans comply with any joint recommendations by RCGs, where these exist and have been approved by the Commission. (see section 5.1.2).

Member States would be required in the guidance on Annual Reports issued by Commission services to provide **quality indicators** (e.g. agreed at a regional level, depending on the regional sampling programme) in their Annual Reports, to inform data users on the data

⁸⁶ STECF 14-02 report http://stecf.jrc.ec.europa.eu/documents/43805/658649/2014-02_STECF+14-02+-+Revision+of+DCF_JRC89196.pdf

quality and so that RCGs and the EUCG can assess these quality indicators and recommend remedial action if they are considered insufficient.

Beyond these legislative provisions, the future IT systems/databases for DCF data provision to data users should include **automated quality checking procedures**, building on those already being piloted by Member States or in existing supra-national databases such as the JRC, Eurostat or DCF regional databases.

5.5. Improving availability of data

Background and legal provisions of the DCF

Under the current DCF Regulation, each Member State is required to upload the data collected under the DCF into a national database (Article 13). Data are owned by and exclusively accessible to that Member State, with one exception: the Commission may consult information about what data are stored in the database (metadata) (Article 16).

A distinction is made between several types of data: with a view to personal or commercial data protection, simple access to the raw data in national databases by any third party is not provided for in the current DCF, and raw data (called primary data, and defined in Article 2) are transformed by Member States into detailed and aggregated data before they are transmitted to end-users (Articles 17, 18, 19). Detailed data is defined (Article 2) as data based on primary data in a form which does not allow natural persons or legal entities to be identified directly or indirectly. In some cases, e.g. for small segments of the fleet, this is not possible, and consequently, data are kept confidential for an entire category of data.

Whilst it is recognised that the DCF represents a major progress in the availability of data on fisheries at Member States and EU level, improvements on the following four points are needed in order to increase the availability of data both for scientific end-users and for other interested parties (see **Table 8**).

A first issue is the **complexity and cost of the storage and provision of data**. Data currently find their way to end-users through data transmission or "**data calls**" (Articles 18-20). Many scientific bodies, such as ICES, issue several data calls every year (see **Figure 3**). The Commission may also launch data calls, and does so regularly on behalf of the STECF e.g. for the purpose of drawing up annual economic reports on the fisheries, aquaculture and processing sectors.

The number of data calls per Member State varies hugely depending on the size of their sector (number of stocks fished, for example), from half a dozen, to around 50 data calls per year⁸⁷. A study on DCF data storage and transmission⁸⁸ estimated, on the basis of a consultation with Member States, that responding to DCF data calls requires at national level between 10 to 1000 person-days annually, and around 4,000 person-days (or 20-25 person-years) annually at EU level.

⁸⁷ Based on information reported by Member States in their DCF Annual Reports

⁸⁸ http://ec.europa.eu/fisheries/documentation/studies/scientific-data-storage/index_en.htm

Figure 3: Data transmission to end-users via "data calls"⁸⁹

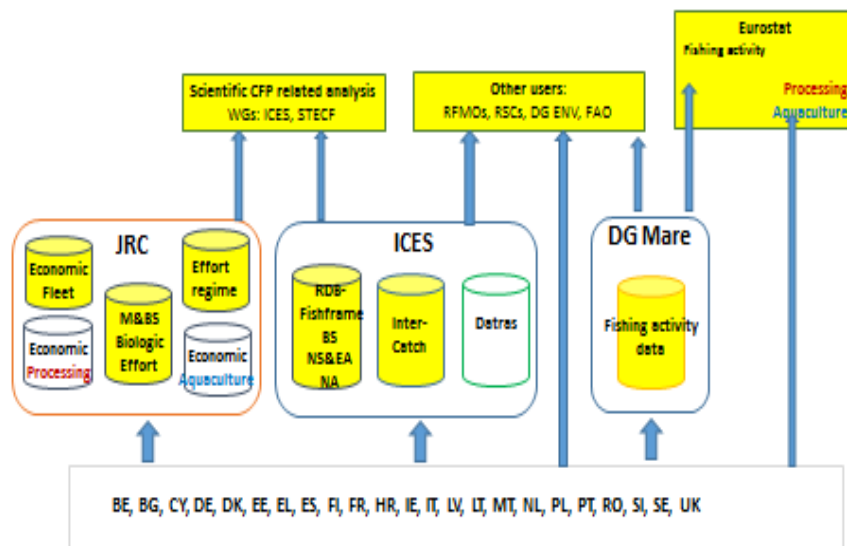

Source: the DCF Database Feasibility Study⁹⁰

Member States are obliged to respond to these data calls by sending the requested data in the specified format within a deadline (1-3 months depending on the purpose of the data request) to the end-user (Article 20). Member States' insufficient or lack of response to data calls is one of the two major criteria for reduction of EU co-financing (Article 8 (5) (c)).

The current set up leads to many parallel data calls for the same or similar data, where Member States have to convert data to the specific requirements of end-users, or have to respond to data calls at different times of the year and thus having to regularly update the results and applying different quality assurance procedures etc. A study on DCF data storage and transmission (see part 2.2.7)⁹¹ concluded that collecting data or doing separate data calls for all various different purposes is wasteful in terms of resources and puts an unnecessary burden on Member States. The study pointed out that this burden could be reduced if Member States had to process data only once in a common internationally accepted data format, ensuring the (updated) data are made available to end-users at an agreed annual cut-off date and leaving the further processing and formatting of data to end-users.

A recent step toward better access to and management of data is the creation of **DCF regional databases (RDBs)**, in some marine regions, containing detailed biological stock-related data and aggregated fishing activity data collected by the Member States as well as data processing

⁸⁹ MBS = Mediterranean & Black Sea. CR = Control Regulation. RDB = regional Database. NS&EA = North Sea & Eastern Arctic. WG = Working groups. FAO = Food & Agriculture Organization

⁹⁰ http://ec.europa.eu/fisheries/documentation/studies/scientific-data-storage/index_en.htm

⁹¹ http://ec.europa.eu/fisheries/documentation/studies/scientific-data-storage/index_en.htm

and analysis tools to extrapolate these data to the total catches by all fisheries types (metiers). RDBs have been created to facilitate and harmonise data management for the Member States when responding to data calls of regional end-users such as the Regional Coordination Meeting. Each Member State keeps access to and ownership of its own data and it can restrict the access rules and even withdraw the data. However, experience with these RDBs has revealed that some Member States are reluctant to take part in the absence of a clearly defined legal framework regarding the status and use of the data in these supra-national databases.

The process is further complicated by the internal complexity within Member States. All Member States store primary data (biological, socio-economic and fishing activity data) in various separate databases, each of high quality, but managed by different institutions or Ministries not always entitled to provide data to each other or to a central database for confidentiality reasons⁹². Despite the requirement to establish a network of databases at national level (Art. 8.1 of the Commission Regulation 665/2008), none of the Member States have linked all national partners' databases, and only four Member States have developed a central database, which effectively addresses the obligation above. Having data spread out in several places at national level, and managed by different bodies, adds complexity, cost and delay for Member States to analyse data nationally, and to provide data to supra-national data users.

Several Member States are working to improve that situation, however, no rules currently exist at EU level to harmonize or guide this process, and the national initiatives are therefore being done in parallel, using different IT solutions. Again, a more harmonized approach would reduce costs and increase ease of access at supra-national level by having compatible formats.

The second issue is **compliance** by Member States with their obligation to provide data to end-users. The way the Commission currently checks this obligation is by requesting **feedback from end-users on data received in data calls**. This ex-post evaluation has worked imperfectly. Assessment of Member States' performance is dependent on feedback and goodwill of the end-user. However, end-users have no legal obligation to help the Commission, and often lack the resources to reply to Commission's requests..

Also, there is a lack of possibilities to enforce correct and timely responsiveness to data provision, which leads to delays for end-users to obtain the data, which are often not in the right format and not provided via the right channel, resulting in an important extra workload for end-users to process the data, and in an inefficient system of evaluating the performance of Member States in providing data.

A third issue is **restrictions on the use of data** collected under other frameworks. Whilst access to, or provision of data collected under the DCF is satisfactory (essentially biological and socio-economic data), end-users have encountered difficulties to **use data on fishing activity** (e.g. on landings, effort, VMS specified by area and type of fisheries) obtained under the Control Regulation. As these data are collected at the level of single vessels' activity, this regulation is subject to rules on protection of personal data and stipulates that data may only be used for the purpose for which they were obtained, i.e. control and enforcement. The use of fishing activity data for scientific purposes is not excluded, but the Control Regulation requires that the authorities providing the data give their express consent for the use for other purposes than control, and that in such case, data should be anonymised or, if not possible, encrypted (Article 116 (5)).

⁹² http://ec.europa.eu/fisheries/documentation/studies/data/documents/analysis-of-cross-cutting-issues-2014_en.pdf

In most Member States, **arrangements on data access** have been made between the national fisheries control authorities and the scientific institutes designated for carrying out the DCF work, such as setting up several levels of restrictions on data availability. Therefore, by and large, access to fishing activity data by scientists is generally ensured, at least at national level. However, experience shows that personal data protection may be used to justify national rules preventing access to the data by “non-control” people, or by scientific experts who are non-nationals of the concerned Member States, preventing therefore end-users to perform fully their tasks.

The current state of play is unsatisfactory because scientific advisors need data on fishing activities to extrapolate biological data on individual fish samples to the total catch and thus the state of the fish stocks, an essential step e.g. for estimating Total Allowable Catches and Quotas. These data are also needed for evaluating the introduction and impact of the discard ban, for the economic evaluation of the fisheries sector, for environmental impacts of fishing e.g. on habitats etc. There is therefore a need for EU-wide clear and harmonised rules on access to fishing activity data if one is to progress towards exchange of data between Member States and facilitate access to fisheries data.

The fourth issue is that **DCF data are under-utilized** beyond the "traditional" end-users i.e. scientific bodies involved in fisheries management. This is due to the current difficulties in accessing DCF data, due to the system of data calls, and the fact the data are currently stored in many different places, as detailed above. This represents a huge wasted potential. Collected data are only sent upon requests from end-users who are aware of the existence of the data, while these and similar data are needed by several other interested parties, who do not know about the existence of the data, while data collectors are not aware of the potential data users. These users may use data from other sources that do not match their needs or they may collect the same data in parallel. Thus, resources are wasted and opportunities are missed to optimize policies. E.g. it would be in the interest of both the fisheries and the energy sector to use the most accurate information available in an early stage in the planning of wind farms.

It is therefore important to allow for the availability of data to a wider public in order to save resources and profit from the synergies created by cross-cutting interdisciplinary links between different fields. In the Commission Staff Working Document on Marine Knowledge 2020: roadmap⁹³, many more groups of data users were identified who could profit from fisheries data such as users involved in marine policy planning, operators carrying out socio-economic impact assessments for marine projects. Currently, these users are not even aware of the existence of these data or do not know exactly what type of data are available resulting in duplication of data collection. E.g. according to a study cited in this Commission Staff Working Document, for offshore wind farms impact assessments more than 8 million € is spent on fisheries data.

The Commission, supported by Council and European Parliament, announced in its Communication on Blue Innovation⁹⁴ the intention to replace the "present fragmented, inaccessible and inhomogeneous repositories of marine data in the EU by a sustainable process whereby data is easily accessible, interoperable and free of restrictions on its use". The Commission considers that this can be done by improving EMODnet and integrating it with other EU initiatives such as the Copernicus Marine Service, the DCF and the Water

⁹³ <http://eur-lex.europa.eu/legal-content/EN/TXT/PDF/?uri=CELEX:52014SC0149&from=EN>

⁹⁴ <http://eur-lex.europa.eu/legal-content/EN/TXT/PDF/?uri=COM:2014:254:REV1&from=EN>

Information System for Europe⁹⁵, using common European standards. There are also further possibilities for the greater involvement of the private sector and for using funding for IMP under the EMFF. Horizon 2020⁹⁶, the new programme for Research and Innovation, might also contribute to ease access to data and foster interoperability through its funding instruments.

Table 8: Needs the DCF should address: Ensure broad availability of DCF data to data users in a timely manner.

Problems identified	Objectives of revision	Options for addressing problem	Proposed solution
<p>1. Data calls system is too burdensome for Member States and inefficient for end-users as data only available to individual end-users upon request and not to others.</p> <p>Supra-national data bases still at an early stage and lacking the appropriate legal frameworks</p>	<p>Reduce the burden of aggregation on Member States by moving from a push to a pull system.</p> <p>Involve end-users in the process early on.</p> <p>Clarify the legal status of supranational data bases and data uploaded thereof</p> <p>Harmonization of basic rules for interoperability</p>	<p>Four scenarios for data availability at supra-national level⁹⁷:</p> <p>i) one supra-regional data base</p> <p>ii) several regional nodes</p> <p>iii) one European network</p> <p>iv) one fisheries data hub</p>	<p>Allow for the gradual move from data push to pull system to ensure data availability (still allowing for the data call system initially).</p> <p>Define in DCF Regulation the basic rules and principles for data availability, including rules on personal data protection.</p> <p>Develop an IT system for DCF data availability that builds on database feasibility study and ensuing consultations/further feasibility analysis.</p> <p>DCF Regulation to include generic rules on this and Commission to set out details further, upon results of further feasibility analysis.</p>

⁹⁵ The Water Information System for Europe (WISE), a gateway to information on European water issues, including marine waters, for the general public and stakeholders: <http://water.europa.eu/info>.

⁹⁶ **Regulation (EU) No 1291/2013 of the European Parliament and of the Council** of 11 December 2013 establishing Horizon 2020 - the Framework Programme for Research and Innovation (2014-2020)

⁹⁷ For further detail see Section 2.2.7. or http://ec.europa.eu/fisheries/documentation/studies/scientific-data-storage/index_en.htm

<p>2. Checks of MS compliance with obligation to provide data to end-users is too burdensome and slow</p>	<p>Reduce burden and improve quality of compliance checks for all actors involved allowing also to speed up the process.</p>	<p>Continue basing assessment of MS compliance on feedback from end-users but try to accelerate the process through improved cooperation with end-users and investment of increased resources.</p> <p>Move to system where comparison between requirements and results (i.e. what data MS made available) are largely automatized in IT system, including automatic quality, timeliness and completeness check.</p>	<p>Move to system where comparison between requirements and results (i.e. what data MS made available) are largely automatized in IT system, including automatic quality, timeliness and completeness check.</p>
<p>3.</p> <p>Accessibility to fishing activity data by end-users is too limited, in some Member States, and at supra-national, to enable adequate application of CFP.</p> <p>This is due to restrictions on multi-purposes use of certain categories of fishing activity data stemming from the Control Regulation.</p>	<p>Ensure scientific end-users at national and supra-national level have the required access to fishing activity data needed for the purposes of the DCF.</p>	<p>Continue with current restrictive access</p> <p>Maintain guarantees for respect of ownership of data in national databases or supra-national databases.</p> <p>Fishing activity data to be made available to end-users at a supra-national level subject to agreed procedure and conditions e.g. restricting some data by giving conditional access but not entirely prohibiting their use.</p> <p>Consult European Data Protection Supervisor (EDPS) in case of doubt.</p> <p>Possible limited modification of Control Regulation.</p>	<p>Maintain guarantees for respect of ownership of data in national databases or RDBs.</p> <p>Fishing activity data to be made available to end-users at a supra-national level subject to agreed procedure and conditions e.g. restricting some data by giving conditional access but not entirely prohibiting their use.</p> <p>Consult European Data Protection Supervisor (EDPS) in case of doubt.</p> <p>Possible limited modification of Control Regulation.</p>

<p>4. DCF data are under-utilized beyond traditional end-users</p>	<p>Allow for Multi-purpose and reuse of data while respecting the rules on personal data protection by balancing the interests of personal data protection against the interest of public or partially restricted data availability</p>	<p>Develop single entry point for accessing DCF data. Make DCF data available to the public at aggregation levels that do not compromise personal data protection rules. Develop the move to a 'pull' system in consistency with other Commission initiatives and policies such as EMODnet & INSPIRE.</p>	<p>Develop single entry point for accessing DCF data. Make DCF data available to the public at aggregation levels that do not compromise personal data protection rules. Develop the move to a 'pull' system in consistency with other Commission initiatives and policies such as EMODnet & INSPIRE.</p>
---------------------------------------------------------------------------	-----------------------------------------------------------------------------------------------------------------------------------------------------------------------------------------------------------------------------------------	-----------------------------------------------------------------------------------------------------------------------------------------------------------------------------------------------------------------------------------------------------------------------------------------------------------------------------------------	-----------------------------------------------------------------------------------------------------------------------------------------------------------------------------------------------------------------------------------------------------------------------------------------------------------------------------------------

Changes to the DCF

The data requests have increased over time and will continue to do so as the impacts of fisheries and aquaculture on the marine ecosystems need to be increasingly well described, and the effects of human activity on the marine environment need more and more to be monitored. The revision of the DCF is an opportunity to, on the one hand, ensure better availability of fisheries data to a wider set of interested parties, and on the other hand, to reduce the burden of data requests on Member States by using recent technological developments.

This new approach should fulfil the mandate set in the new CFP Regulation (Article 25), whereby the availability of data to scientists and to any interested parties must be ensured, save in circumstances where protection and confidentiality are required under applicable EU law. This is further corroborated by the EP green paper on Marine Knowledge 2020⁹⁸ and the Commission Communication on innovation in the blue economy and the accompanying roadmap on marine knowledge⁹⁹, in which a cost benefit analysis is made showing the advantages of lifting restrictions on access to information by making **data multi-purpose and reusable**, provided that rules on personal data protection are respected.

To achieve these objectives, two main changes are necessary, which would enable the four challenges identified above to be addressed. Firstly, the **DCF Regulation** would **clarify the legal framework** by making the DCF the main legal instrument by which Member States are to provide any data necessary to data users, whatever the source of the legal obligation under which data are collected (DCF or any other EU legislation), unless other legal instruments already provide for the availability of the data (e.g. most statistical Regulations).

Regarding the Control Regulation specifically, the DCF would thus only create data collection obligations insofar as they are not already covered by the Control Regulation, whilst the Control regulation would continue to provide the core data on fishing activity (landings,

⁹⁸ http://ec.europa.eu/maritimeaffairs/policy/marine_knowledge_2020/index_en.htm.

⁹⁹ Commission Staff Working Document Marine Knowledge 2020: roadmap Accompanying the document Communication from the Commission to the European Parliament, the Council, the European Economic and Social Committee and the Committee of the Regions Innovation in the Blue Economy realising the potential of our seas and oceans for jobs and growth (SWD/2014/0149 final) <http://eur-lex.europa.eu/legal-content/EN/ALL/?uri=SWD:2014:149:FIN>

catches and effort). Following this alignment, necessary amendments may need to be made to the Control regulation should the need arise to improve availability of data.

It is important that **no generic measures are taken to restrict a priori the access to data**, whether from end-users or from other interested parties. In case the protection of personal data is at stake, it must be ensured that the EU rules on data protection are applied. To that purpose, all steps in the gradual shift to data availability would be done in close consultation with the European Data Protection Supervisor (EDPS). As a principle, the interests of personal data protection should be balanced against the public interest of data availability and in case of conflict, **rather than simply withholding or deleting data, alternatives** should be developed to ensure the interests of scientific research and stock assessment advice. Specifically, the **DCF Regulation** would require the Commission, Member States, as well as scientific advisory bodies and any relevant end-users involved in developing compatible data storage and exchange systems, to ensure appropriate safeguards (for example a higher level of aggregation/clustering or anonymisation of data) should they include information relating to identified or identifiable natural persons. In doing so, Member States would be assured that the institution/body receiving the data produce aggregated figures while not disclosing the underlying detailed data.

Secondly, **use should be made of technical developments**, in particular the development of IT systems, building on existing experiences of data pooling at regional level, to greatly simplify data provision to end-users and to the broader public by providing a single access point to DCF data. Ensuring data availability through better interconnection of IT systems would reduce workload and costs for Member States, while offering data users the opportunity to use data in the format, at the timing and at the aggregation level they need. The exact approach to this would be based on the options proposed by the DCF database feasibility study¹⁰⁰, and ensuing consultations, aiming to put forward a simpler, more cost-effective and efficient system for providing DCF data to end-users, and helping Member States in simplifying their IT setup using IT tools in a more systematic manner. The use of such IT tools for storing, processing, exchanging access to data should be in conformity with the INSPIRE Directive 2007/2/EC¹⁰¹.

Such IT developments would also enable automation to a large extent of the verification of Member State **compliance with their obligations** to collect and make available DCF data, through automatic comparisons of data provided by Member States via the future IT system, with their obligations under their national work plans. This may include automatic checks regarding quality of data, timeliness of data submission and coverage which would greatly simplify and speed up the whole compliance process for all stakeholders involved, as well as improving quality by eliminating any human-errors.

The **DCF Regulation** should therefore contain provisions allowing for a gradual shift from "a push" to "a pull system", i.e. to move from a system of data calls initiated by end-users, to a system of data availability ensured by the data providers. Such a system should answer the needs of the traditional end-users under the CFP: data to underpin scientific advice on fish stock management, to evaluate (and mitigate) the effects of fisheries on the marine ecosystem and to evaluate support measures for fisheries and aquaculture. Use of the same data should

¹⁰⁰ For further detail see Section 2.2.7. or http://ec.europa.eu/fisheries/documentation/studies/scientific-data-storage/index_en.htm

¹⁰¹ Directive 2007/2/EC of the European Parliament and of the Council of 14 March 2007 establishing an Infrastructure for Spatial Information in the European Community (INSPIRE). OJ L108, 25.4.2007, p.1

also serve other purposes and therefore extend to other interested stakeholders: fundamental and applied scientific research with potential spinoff to the sector, planning in maritime policy, etc. Specifying rules at EU level regarding a future supra-national IT system for data availability would also serve to reassure Member States regarding the status and use of the data in such a system.

As this evolution requires time to be effective, and consultations are still ongoing on the best design, the revised **DCF Regulation** should only include general provisions reflecting this shift, by requiring Member States to cooperate with other Member States, the Commission, scientific advisory bodies and any relevant end-users to develop compatible data storage and exchange systems, which may also facilitate dissemination of information to other interested parties. More detailed provisions would be developed at a later stage and may be specified by the Commission, once a consensus has been found between Member States on the most appropriate solutions. To this effect, the Commission intends to commission a second feasibility study to further identify the most effective ways forward.

5.6. Data collection in external waters

Background and legal provisions of the DCF

As a general rule, **the rules, principles and methods of the DCF are applied equally in external waters as within the EU**, in accordance with the reformed CFP. Indeed, the current DCF Regulation provides for the collection and provision of data concerning commercial fisheries carried out by EU fishing vessels outside EU waters (Article 3.1).

Similarly, the current DCF contains adequate provisions requiring **Member States to coordinate their National Programmes** with each other and, as far as possible, with third countries in the same marine region, which therefore also applies to fisheries taking place in external waters.

The Regional Coordination Meeting for long-distance fisheries (i.e. in external waters) has been meeting annually since 2010 and key third countries are invited to participate in all RCMs.

The current EU MAP lists certain biological data that must be collected in external waters. In addition, **the current DCF requires that methods used for the establishment of national sampling programmes** be in accordance with the quality standards established by the appropriate RFMOs (Article 9.3). Masters of EU fishing vessels are required to accept on board **scientific observers** designated by the body in charge of the implementation of the National Programme (Article 11.3), including in external waters. Member States must ensure that relevant detailed and aggregated **data are provided** on a timely basis to RFMOs to which the EU is a contracting party or observer (Article 20.1) and that their national experts **participate in relevant meetings** of RFMOs to which the EU is a contracting party or observer (Article 23).

However, some problems have been identified.

The list of biological data to be collected is not fully aligned with international data collection obligations stemming from RFMOs, which has resulted in **incomplete compliance of the EU and the Member States with their data transmission obligations under RFMOs**.

There is also some **lack of clarity regarding the geographic scope** of application of the DCF: although the current DCF Regulation refers to data collection on commercial fisheries within and outside EU waters, Commission Regulation (EC) No. 665/2008 limits the scope of the DCF to RFMO-managed external waters. This leads to two limitations. First, this

provision means that the DCF does not cover waters of third countries with which the EU has a Sustainable Fisheries Partnership Agreement (SFPA), unless these countries are also members of an RFMO. Currently all SFPAs are concluded with third countries whose waters are part of an RFMO, but should the EU sign an SFPA with a country whose waters are not part of an RFMO, then Member States would have no data collection obligation for those fisheries. Secondly, the reference to RFMOs excludes other Regional Fisheries Bodies¹⁰² (RFBs) such as the Fisheries Committee for the Eastern Central Atlantic (CECAF) and the Western Central Atlantic Fishery Commission (WECAFC). Even if in practice, in the case of CECAF, the concerned body has been treated as an RFMO and Member States have sampled the fisheries taking place in that area, such gap may result, in other circumstances, in Member States having no data collection obligations and the EU not providing the required information to enable fisheries management, for example to joint scientific committees established under SFPAs.

Changes to the DCF

It is important to **continue to ensure that DCF covers data collection in all external waters where EU vessels are operating**. No change is required to the **DCF Regulation**, which would continue to provide the basis for data collection on commercial fisheries within and outside EU waters.

The current lack of clarity regarding the geographic scope, which is due not to the DCF Regulation but to the limitations introduced in Commission Regulation (EC) No. 665/2008, will be clarified through the future Commission regulations.

The **EU MAP**, however, should include any data collection obligation stemming from international law, including a list of the exact stocks and variables to be collected per stock (as is currently the case). Having all data collection obligations stemming from different international obligations compiled in one place (the EU MAP) would facilitate implementation and compliance by the EU and its Member States of their international obligations, as well as streamlining and reducing costs of implementation where possible.

In addition, further non-legislative measures would benefit implementation of the DCF in external waters. The EU and its Member States should **promote the DCF methodology with third countries**. This is already being done in some cases, such as through FAO regional projects in the Mediterranean where methodologies for research surveys at sea are inspired by the EU MEDITS and MEDIAS models. This could be more systematically extended to other partner countries.

5.7. Programming and reporting

The current DCF Regulation provides for the establishment of a **triennial EU MAP** (Article 3) but does not contain any provision regarding amendment of this programme. In practice, this has resulted in a situation where the EU MAP is not modified despite emerging needs

¹⁰² Regional Fishery Bodies (RFBs) are a mechanism through which States or organizations that are parties to an international fishery agreement or arrangement work together towards the conservation, management and/or development of fisheries. Some RFBs have an advisory mandate, and provide advice, decisions or coordinating mechanisms that are not binding on their members. Some RFBs have a management mandate – these are called Regional Fisheries Management Organizations (RFMOs). They adopt fisheries conservation and management measures that are binding on their members.

from end-users regarding new data sets (e.g. regarding biological data on boarfish, due to the development of a fishery for this species)¹⁰³.

In line with this, Member States are required to submit **triennial National Programmes** (NP) which includes their national obligations under the DCF (Article 4) – essentially the sub-set of the EU MAP that applies to them. **Member States could amend their NP annually**. NPs were adopted, following an evaluation by the STECF (Article 6), through an individual Commission Decision for each Member State. For 2011-2013, 22 NPs were adopted. For 2012, the Commission adopted 11 amended NPs, whilst for 2013, two amended NPs were adopted (plus Croatia's 2013 NP was adopted), giving a total of 36 Commission Decisions for adoption of NPs in three years.

Member States were also required, until and including 2013 (under direct management), to separately submit a triennial **budget** forecast, but also to submit, as formal request for financing, an annual update. On this basis, the Commission set the maximum co-financing amount (50% of a Member States' approved budget) and approved it through an annual financing decision. This has meant 9 financing decisions for the period 2011-2013, in addition to the above decisions approving the NPs.

Member States are required to **report** annually on scientific and financial implementation of their NP (Article 7). These reports are approved by the Commission following an evaluation by the STECF, and made public via the DCF website. The approval of the reports leads often to long exchanges between Member States and Commission as a result of comments made by the STECF and Commission services' scrutiny (see also section 5.4 on data quality).

As demonstrated by the number of Decisions adopted each year, this system is **administratively very heavy** and, due to the detailed technical nature of NPs, and their size, procedures for adoption were time-consuming and lengthy. In practice NPs and their amendments, as well as financing decisions, were adopted during the year to which they referred. This resulted in an uncertainty for Member States every year regarding the programme to be implemented and the EU co-financing they would be receiving. The split between financing decisions and Decisions adopting the data collection programme also resulted both in an increased number of procedures as well as a greater disconnect between the programme and its financing. Even if certain Member States did not need to amend their NP during the three year period, they did require having a new budget adopted every year.

Changes to the DCF

The new DCF Regulation should provide for the establishment of an **EU MAP without a time limit**. It would also contain provisions regarding the **amendment** of the EU MAP to ensure that it can be updated when required, and following a clearly established procedure, including consultations to be carried out by the Commission, criteria to be followed to decide on inclusion of (new) data (see also section 5.1.1).

As of 2014, programming of data collection activities will take place on the basis of the **rules established in the EMFF**. Member States shall submit an **EMFF Operational Programme** (OP) including a section on data collection (Article 18(1)p of the EMFF). This should contain a description of the activities of data collection, of the data storage methods, data management and data use and a description of the capability to achieve sound financial and administrative management of the data collected. The OP section on data collection will contain more generic information on the aforementioned topics, and will be less detailed than the current

¹⁰³ As a transition measure, the EU MAP 2011-2013 was rolled-over as is, to cover the period 2014-2016¹⁰³. National Programmes for 2011-2013 were also rolled over to cover the period 2014-2016

NPs. This will be adopted by the Commission and will constitute the basis for Member States' obligations, as well as for the EU co-financing of these activities. In other words, instead of two successive, detailed triennial decisions on the NP, coupled with annual financing decisions, the programming of data collection activities will require only one single, strategic Commission decision for seven years.

The EMFF OP will be complemented by a **national work plan**, containing greater detail on activities to be carried out, to be submitted annually unless the national work plan of the previous year still applies (Article 21 of the EMFF). This work plan will be adopted by the Commission through simplified procedures. When setting up implementing rules on the submission of the national work plan, the Commission would draw lessons from past experience and simplify the process of submission, approval and reporting on these work plans, so as to maximise the benefits of the simplification brought by the new set up.

Article 25 of the CFP maintains the obligation for Member States to **report** annually on the execution of their national data collection programmes. Consequently, the new DCF should maintain provisions on annual reporting, and evaluation by the STECF. The **format, however, would be greatly simplified** and its submission would be largely automatized. As far as possible, the format of the Annual Report should be compatible with other related reporting exercises such as that under the MSFD.

This Annual Report is a different report to the Annual Implementing Report under the EMFF, which will primarily contain financial information on data collection, and not on implementation of the scientific obligations. This reporting will be much less detailed than the previous DCF financial reporting and verifications procedures and templates.

Figure 4 presents the key changes from the previous (current DCF, direct management) to the future system (new DCF, shared management under the EMFF), both in terms of scientific and financial programming and reporting obligations.

Figure 4: Changes in programming and reporting between previous and future system. Improvements (simplification or increased duration of a measure) highlighted in italics.

	Before	After
<i>EU level</i>		
DCF Regulation	No time limit	No time limit
Multiannual Programme	3 years	<i>No time limit</i> (but provisions for amendment)
<i>National level</i>		
Scientific programming	3 years (1-3 Decisions per Member State per 3 year period)	<i>7 years</i> (EMFF OP). + National work plan (<i>max. 1 Decision per Member State per year</i>)
Financial programming	Annual (+/- 3 Decisions per year in total)	<i>7 years</i> (EMFF OP) <i>No separate Decision</i> – included in above.
Scientific reporting	Annual	Annual (<i>but lighter</i>)
Financial reporting	Annual	Annual under EMFF (<i>but lighter</i>)

The main advantages of the new set-up are that financial and scientific programming will take place over a longer time span, giving more predictability and security to Member States. This

change will also result in a lighter administrative burden, through a need for fewer Commission Decisions and faster procedures, thanks in part to simplified formats for programming and reporting. A single decision will also link the scientific and financial programming, under the EMFF, ensuring greater alignment.

6. LEGAL ARCHITECTURE

The legal set-up for the future DCF is described in **Figure 5** and an overview of the contents of the future DCF Regulation and future implementing acts is included in **Annex VII**.

Figure 5: Legal set up for the future Data Collection Framework

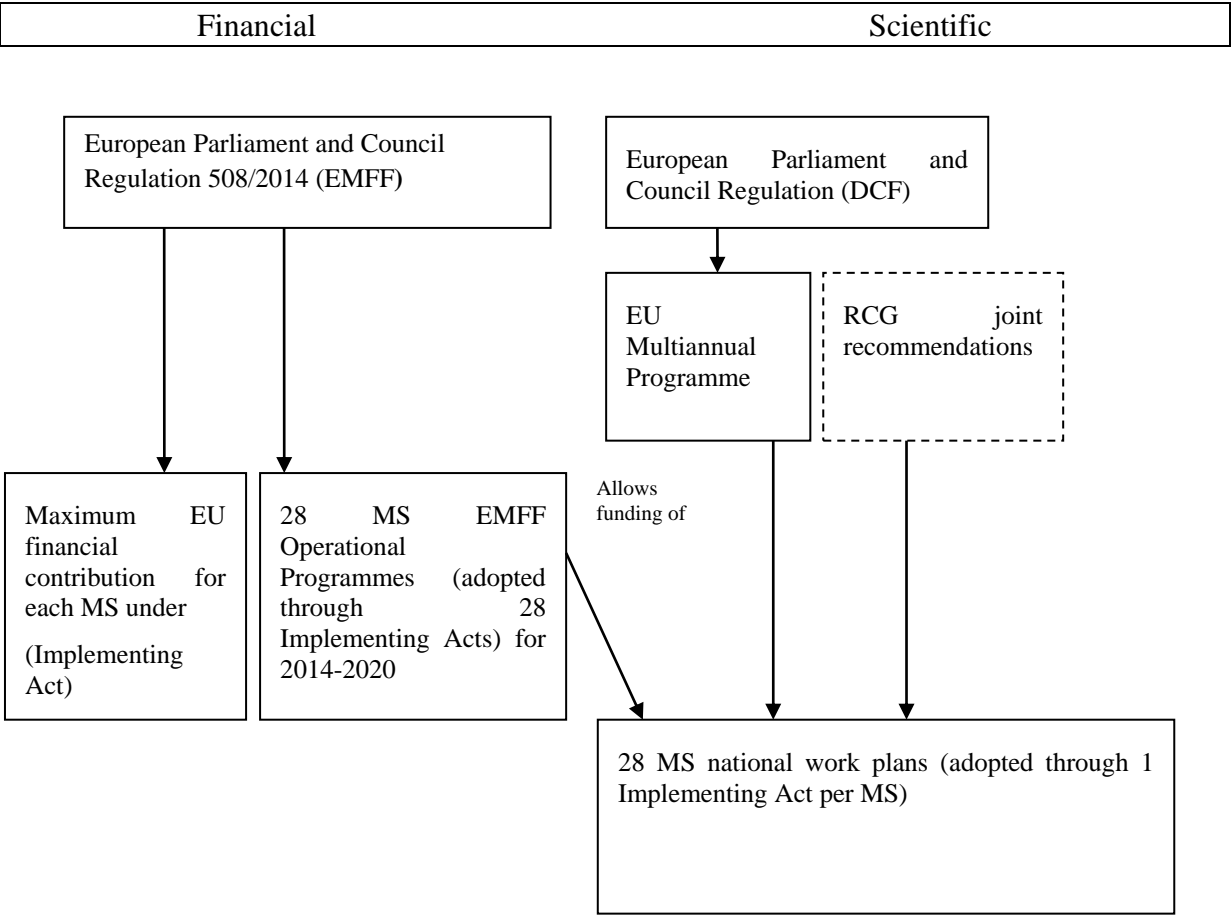

7. ANNEXES

Annex I

Consultations on the revision of the Data Collection Framework

Meetings

Member States Experts (1 December 2011, Brussels, Belgium):

As part of the STECF EWG11-19 meeting. Outcomes available from EWG report: [Scientific, Technical and Economic Committee for Fisheries \(STECF\) - Review of the Revised 2012 National Programmes and on the Future of the DCF \(STECF-12-02\)](#)

Member States National Correspondents (12 December 2011, Brussels, Belgium):

Consulted on the basis of a non-paper (Issues paper). Meeting minutes: [hyperlink](#)

Advisory Councils (21 February 2012, Brussels, Belgium):

RACs were informed of the process of the update of the DCF during a meeting organized by DG MARE.

Regional Fisheries Management Organisations (13 March 2012, Brussels, Belgium):

RFMOs informed of the state of play on DCF revision during a meeting organized by DG MARE.

Member States Experts (12-16 March 2012, Ispra Italy):

Dedicated STECF EWG meeting 12-01 on the new DC MAP. Overview of discussions available in EWG report: [Scientific, Technical and Economic Committee for Fisheries \(STECF\) Review of Proposed DCF 2014-2020 Part 1 \(STECF-12-07\)](#)

Member States National Correspondents (19 March 2012, Brussels Belgium):

Consulted on the basis of a non-paper (Issues Paper). Meeting minutes available: [hyperlink](#)

NGOs (8 June 2012, Brussels, Belgium):

Mare consulted NGOs on their views for the revision of the DCF.

Member States and European Parliament (22 June 2012, Brussels Belgium):

Consulted on the basis of a non-paper (Issues & Options).

Commission Services (ENV, ESTAT, JRC) (17 July 2012, Brussels, Belgium):

Consulted on the basis of a non-paper (Issues & Options).

Member States National Correspondents (17 July 2012, CCAB):

Consulted on the basis of a non-paper (Issues & Options). Meeting minutes available: [hyperlink](#)

Member States Experts (1-5 October 2012, Brussels, Belgium):

Dedicated STECF EWG meeting 12-15 on the new DC MAP. Report available: [Scientific, Technical and Economic Committee for Fisheries \(STECF\) REVIEW OF PROPOSED DCF 2014-2020 PART 2 \(STECF-13-01\)](#)

Member States and European Parliament (1 February 2013, Brussels Belgium):

Consulted on the basis of a non-paper (Outline of DC-MAP).

Member States National Correspondents (12 February 2013, CCAB):

Consulted on the basis of a non-paper (Outline of DC-MAP). Meeting minutes available: [hyperlink](#)

Member States Experts (11-15 March 2013, Ispra, Italy):

Dedicated STECF EWG meeting 13-02 on the new DC MAP. Report available: [hyperlink](#)

EU scientists participating in RFMOs (9 April 2013, Brussels, Belgium)

Meeting participants consulted on the final draft of the External evaluation of the DCF.

Member States Experts (10-14 June 2013, Varese, Italy)

Dedicated STECF EWG meeting 13-05 on the new DC MAP. Report available: [Scientific, Technical and Economic Committee for Fisheries \(STECF\) - Review of DC-MAP – Part 2 \(STECF-13-12\)](#)

Member States National Correspondents (7 June 2013, CCAB):

Consulted on the basis of a first draft of the DC-MAP. Meeting minutes: [hyperlink](#)

DG ENV (23 Sept 2013, MARE):

DG ENV consulted on revision of DCF.

NGOs (25 Sept 2013, MARE):

NGOs consulted on revision of DCF.

Member States Experts (25-28 November 2013, Brussels, Belgium):

Dedicated STECF EWG meeting 13-18 on the revision of the DCF and the future EU MAP. Report available: [Scientific, Technical and Economic Committee for Fisheries \(STECF\) REVISION OF DCF \(STECF-14-02\)](#)

All stakeholders (Permanent Representations, MEPs, Member States, the scientific community, end-users, NGOs, RACs) (16 January 2014, Brussels, Belgium):

Consulted on the basis of a non-paper on key changes proposed to the DCF Regulation. Minutes available:

http://ec.europa.eu/fisheries/cfp/fishing_rules/data_collection/doc/20140116-dcf-stakeholder-workshop-minutes_en.pdf

Member States Experts (24-28 February 2014, Hamburg, Germany):

Dedicated STECF EWG meeting 14-02 on the revision of the DCF and the future EU MAP. Report available: [Scientific, Technical and Economic Committee for Fisheries \(STECF\) - DCF Revision - part 4 \(STECF-14-07\)](#)

EFARO meeting (11 February 2014):

Meeting on the revision of the Data Collection Framework (DCF), focusing on issues related to regional coordination.

Member States Experts (20-24 October 2014, Hamburg, Germany):

Dedicated STECF EWG meeting 14-17 on preparations for future data collection under the revised DCF. Report available: [Scientific, Technical and Economic Committee for Fisheries \(STECF\) - website](#)

Member States Experts (25-28 November 2014, Brussels, Belgium):

Dedicated STECF EWG meeting 14-18 on Review of DCF National Programme amendments for 2015 & development of the revised DCF Multiannual Programme. Report available: [Scientific, Technical and Economic Committee for Fisheries \(STECF\) - website](#)

Written consultations

A **public consultation** via a green paper took place on Marine knowledge in 2012¹⁰⁴.

ICES was consulted in writing on 26 March 2013.

GFCM was consulted in writing in July 2013.

EU scientists taking part in **RFMOs** were consulted in writing in March 2014.

Fisheries Directors of the 28 EU **Member States** were consulted in writing in March 2014.

The 28 EU member States, the DCF Regional Coordination Meetings, key end-users of DCF data (GFCM, ICCAT, ICES, STECF) were consulted in writing in October 2014 regarding DCF data storage, transmission and dissemination.

¹⁰⁴ http://ec.europa.eu/dgs/maritimeaffairs_fisheries/consultations/marine-knowledge-2020/index_en.htm

Annex II

Feasibility study on data storage and transmission¹⁰⁵ – details on the four possible future scenarios and main conclusions on the current set up.

The four possible future scenarios considered under the above-mentioned study can be summarized as follows:

- **Supra-regional database.** This scenario envisages the creation of one database containing detailed biological, economic and fisheries data.
- **Regional nodes.** This scenario would be based on five regional databases (RDBs) for the Baltic Sea, North Sea and NE Atlantic, North Atlantic, Mediterranean and Black Sea and 'Distant waters', containing biological, economic and fisheries data.
- **Network.** In this scenario, the primary biological, economic and fisheries data would be stored only in the national databases, and these databases would be linked through a web-based interface (central platform).
- **Fisheries data hub.** This scenario would combine three thematically specialized databases (biological data, fleet economic data and fisheries data), which would be linked, so that biological and economic data can be aggregated.

Regarding the current set up:

- The study confirmed that answering **data calls represents a large burden on Member States**, due in part to the increasing number of data calls but also to the diversity of aggregation levels required by different data users and the fact that these often change over time.
- The study identified many areas of **overlap in the legislative frameworks on data collection** (this is elaborated further in section 5.9.1 and see also **Annex III**)
- **Regarding data storage and transmission**, overlaps concern **fishing activity data** (catches, landings and effort). These data are mainly collected under the Control Regulation, and are then provided to the various Commission services, ICES and other bodies often at different aggregation levels. The study identified the lowest common denominator in terms of aggregation levels (by fleet segments) from which the different data users could aggregate the data to meet their respective needs.
- The organization of **biological data** varies between fishing areas, with data for the Atlantic stored in three databases (the RCM's regional databases and two ICES databases), for the Mediterranean & Black Sea stored at the European Commission (JRC) and for large pelagics in external waters stored at the French Institut de Recherche pour le Développement.
- Regarding **economic data**, the situation differs by sector. Fleet economic data (earnings and costs) is stored only at the JRC. Economic data on performance of the aquaculture sector (earnings and costs) and on production (volume and value) is also stored at JRC. Eurostat stores data on aquaculture production but not on economic performance. Duplication in data transmission from Member States to both the JRC and Eurostat therefore occurs for aquaculture production. Regarding the fish processing sector, both the JRC and Eurostat (under the Structural Business Survey -

¹⁰⁵ http://ec.europa.eu/fisheries/documentation/studies/scientific-data-storage/index_en.htm

SBS) store data on performance of the sector (costs and earnings). Some elements of this data collection overlap, while some are unique to each system.

ANNEX III

Overlaps and duplications of data collection and/or reporting

Data	Data source (Regulation)	Collected by	Reported by	Disseminated/p ublished by	Made available to
Aquaculture sector					
Aquaculture production data (volume & value)	Economic surveys per (major) production unit (R762/2008)	National economic authorities	National statistical correspondents	Commission (EUROSTAT)	General public (low aggregation level, few parameters)
Aquaculture economic data (costs & earnings) & production data (volume & value)	Fisheries surveys per enterprise (including minor) (R199/2008)	National fisheries authorities	National Correspondents for Fisheries Data Collection	Commission (DG MARE/JRC)	Commission (high aggregation level, more parameters)
Fish processing sector					
Processing industry data (only those from Structural Business Statistics)	Economic surveys per enterprise (R295/2008)	National economic authorities	National statistical correspondents	Commission (EUROSTAT)	General public (low aggregation level, few parameters)
Processing industry data (more data)	Economic surveys per enterprise (including minor) (R199/2008)	National fisheries authorities	National Correspondents for Fisheries Data Collection	Commission (DG MARE/JRC)	Commission (high aggregation level, more parameters)
Fishing activity					
Data on fishing capacity, effort and landings	Logbooks, landing declaration, sales notes, inspections, VMS (R1224/2009; R199/2008)	Fisheries control authorities,	National control authorities	Commission (DG MARE/JRC)	Commission End-users DCF (raw or detailed data) RFMOs
Data fishing on capacity, effort and landings	Ad hoc catch & effort surveys, Control Regulation: logbooks, landings declaration, sales notes, inspections, VMS (R1224/2009; R1921/2006, 218/2009, 217/2009, 216/2009)	Statistical offices, Control authorities	National Correspondents for Fisheries Data Collection National statistical correspondents	Commission (EUROSTAT)	General public (aggregated) or RFMOs

ANNEX IV

SWOT Analysis of the DCF

STRENGTHS

Established since 2002 – **time series** available.
Common EU framework, **harmonisation** in data collection. Introduced standards.

DCF data is instrumental to **policy making** and DCF has improved availability and quality of data for **scientific advice**. Most data collected are **relevant and useful** to end-users.

Generally relatively good **data quality**. Improvement over previous period.

Key source of **socio-economic data** on fisheries. Allows bio- economic analysis.

Research surveys and observer programmes well coordinated and biological **data collection well organized** in most Member States.

Metier approach useful way of **providing data** to some end-users and to link biological and economic data.

Some **re-use of data** already occurs eg economic data on processing often taken from SBS¹⁰⁶.

Regional co-ordination and co-operation has increased. Great strength of DCF. Regional databases have simplified regional data analysis and transmission.

Compliance variable between Member States but generally good.

Financial support available.

OPPORTUNITIES

Alignment with **needs of new CFP** – freshwater aquaculture, sustainability of aquaculture, ecosystem data.

Reducing overlaps with other EU legislation and increasing reuse of data for different purposes eg DCF data on ecosystem to address some of the needs of the MSFD¹⁰⁷.

Simplification through developing a single **overarching framework** for availability of CFP fisheries data. Increasing and simplifying **availability of data**, to also facilitate multi-purpose use of data and to reduce cost of data transmission through data calls.

Possibility to **improve confidence in fisheries advice** by allowing validation of results by wider community of scientists

Simplifying EU legislation by allowing Member States and regions to determine some of the detail regarding the data to be collected

Increase co-operation with **end-users** in determining data to be covered by DCF

Increase **synergies between Member States** to share best practice and increase efficiency.

Build on and strengthen existing **regional co-operation**, provide more incentives for this.

Increase possibilities of **geographic analysis** of socio-economic impacts of policies.

Expand and improve data collection on **aquaculture** and **recreational fisheries** (basic socio-economic data and ecosystem data).

Reduce administration burden by simplifying and automatizing **reporting**.

Improve **data quality** further, through increasing quality control and transparency of methods used.

Additional **financial resources** are available (EMFF).

Key EU instruments - DCF, CFP and EMFF - will be aligned.

Opportunity to better link processes such as Marine Knowledge 2020, EMODnet, CISE¹⁰⁸ etc.

WEAKNESSES

No longer fully aligned with **needs of new CFP** eg new emphasis on sustainable aquaculture, assessment of policy impacts, landing obligation. Insufficient availability of **ecosystem data** for ecosystem-based management.

Insufficient flexibility to respond to changing end-user data needs.

Redundancies and **overlaps** with other EU legislation.

Dialogue with **Data End-users** not sufficient.

Metier approach not the most appropriate for **collecting data** – very resource intensive and can result in excessive sampling to reach quality targets. Metier data not used by RFMO.

Recreational fisheries difficult/resource intensive sector to cover and hard to get reliable data.

Small-scale fleet can be difficult to sample, including for data on capacity, effort and landings.

Practical difficulties to carry out observer at sea programmes, widespread problems of **access to vessels**. Can result in biases in data.

Quality targets unrealistic and inappropriate. Level of **quality control** and methods vary greatly between Member States.

Not enough **follow-up of recommendations** made by RCMs and STECF.

Administrative burden (programming, reporting). Insufficient **administrative capacity and/or national financing** in some Member States to implement the DCF properly.

Data transmission procedures (data calls) very resource intensive for Member States and for end-users, formats of data calls vary over time and between end-users. Problems of timeliness of **data delivery** and with data **formats**.

Wide divergence in **data storage and transmission systems** across Member States and the incompatibility of IT systems among and within Member States

Insufficient access to data for users outside the fisheries community, particularly for determining impact on ecosystem

Reliance on opinion for fisheries advice from limited group of scientists having **access to data**

Complexity of legislation

Compliance mechanism not sufficiently dissuasive

THREATS

Some **time series** could be lost if reduced EU-level obligations

Difficulties in dealing with cases of **non-compliance** if requirements are decided at regional level rather than enshrined in EU legislation.

Regional coordination groups not (all) able to deal with increase in tasks. Time may be required before RCGs can deal with these new tasks. Some Member States may not want to increase regional cooperation or may not agree with decisions of RCGs.

Reduced quality due to **transition to new system** (e.g. new methodologies)

Costs and time needed for **IT developments** to move to a more efficient system of data availability.

Duplication of **quality assessment** – at national level for compliance purposes and at regional level to inform end-users on quality.

Administrative capacity (in the form of human expertise, or organizational arrangements) takes time to develop and may not be sufficient in some Member States at time of adoption of amended DCF to fully implement it.

Interests of some public bodies to remain as **monopoly providers** of fisheries data

¹⁰⁶ Structural Business Statistics of Eurostat

¹⁰⁷ Marine Strategy Framework Directive

ANNEX V

Overview Table of Marine Strategy Framework Directive Descriptors, Criteria and Indicators¹⁰⁹. Key: S=State, I = Impact, P = Pressure.

Descriptors	Criteria		Type	Indicators		Type
Descriptor 1: Biological diversity	1.1	Species distribution	S	1.1.1	Species distributional range	S
				1.1.2	Species distributional pattern	S
				1.1.3	Species area covered	S
	1.2	Population size	S	1.2.1	Population abundance/biomass	S
	1.3	Population condition	S	1.3.1	Population demographic characteristics	S
				1.3.2	Population genetic structure	S
	1.4	Habitat distribution	S	1.4.1	Habitat distributional range	S
				1.4.2	Habitat distributional pattern	S
	1.5	Habitat extent	S	1.5.1	Habitat area	S
				1.5.2	Habitat volume	S
	1.6	Habitat condition	S	1.6.1	Habitat condition of typical spp. & communities	S
				1.6.2	Habitat relative spp. abundance/biomass	S
				1.6.3	Habitat physical, hydrological & chemical condition	S
	1.7	Ecosystem structure	S	1.7.1	Ecosystem composition & proportions	S
Descriptor 2: Non-indigenous species	2.1	Abundance and state characterisation of non-indigenous species, in particular invasive species	P	2.1.1	Trends in abundance of NIS	P
	2.2	Environmental impact of invasive non-indigenous species	I	2.2.1	Ratio between invasive NIS & native spp.	I
				2.2.2	Impact of NIS	I
Descriptor 3: Commercial fish and shellfish	3.1	Level of pressure of the fishing activity	P	3.1.1	Fishing mortality	P
				3.1.2	Ratio between catch & biomass	P
	3.2	Reproductive capacity of the stock	S/I	3.2.1	Spawning stock biomass	S/I
				3.2.2	Biomass indices	S/I
	3.3	Population age and size distribution	S/I	3.3.1	Proportion of large fish at sexual maturation	S/I

¹⁰⁸ http://ec.europa.eu/dgs/maritimeaffairs_fisheries/consultations/cise/index_en.htm

¹⁰⁹ Criteria and indicators are currently under review that will possibly lead to their revision

Descriptors	Criteria		Type	Indicators		Type
				3.3.2	Mean max. length of all spp. found in surveys	S/I
				3.3.3	95% percentile fish length distribution in surveys	S/I
				3.3.4	Size at first sexual maturation	S/I
Descriptor 4: Food webs	4.1	Productivity (production per unit biomass) of key species or trophic groups	S	4.1.1	Performance of key predator spp.	S
	4.2	Proportion of selected species at the top of food webs	S	4.2.1	Proportion of large fish	S
	4.3	Abundance/distribution of key trophic groups/species	S	4.3.1	Abundance trends of selected groups/spp.	S
Descriptor 5: Eutrophication	5.1	Nutrient levels	P	5.1.1	Nutrient concentration	P
				5.1.2	Nutrient ratios	P
	5.2	Direct effects of nutrient enrichment	I	5.2.1	Chlorophyll concentration	I
				5.2.2	Water transparency related to algae	I
				5.2.3	Abundance of opportunistic macroalgae	I
				5.2.4	Species shift in floristic composition	I
	5.3	Indirect effects of nutrient enrichment	I	5.3.1	Abundance of perennial seaweed	I
5.3.2				Dissolved oxygen	I	
Descriptor 6: Sea-floor integrity	6.1	Physical damage, having regard to substrate characteristics	P	6.1.1	Type, abundance, extent of biogenic substrate	I
				6.1.2	Extent of seabed affected by human activities	I
	6.2	Condition of benthic community	S/I	6.2.1	Presence of sensitive and/or tolerant spp.	S/I
				6.2.2	Multi-metric indexes for benthic communities	S/I
				6.2.3	Proportion of biomass/numbers in the macrobenthos	S/I
				6.2.4	Benthic community size parameters	S/I
Descriptor 7: Hydrographical conditions	7.1	Spatial characterisation of permanent alterations	P	7.1.1	Extent of area affected	P
	7.2	Impact of permanent hydrographical changes	I	7.2.1	Extent of habitats affected	I
				7.2.2	Changes in habitats, in particular functions provided	I

Descriptors	Criteria		Type	Indicators		Type
Descriptor 8: Contaminants	8.1	Concentration of contaminants	P	8.1.1	Concentration of contaminants	P
	8.2	Effects of contaminants	I	8.2.1	Level of pollution effects	I
				8.2.2	Occurrence, origin & extent of acute pollution and impact on biota	P/I
Descriptor 9: Contaminants in seafood	9.1	Levels, number and frequency of contaminants	P	9.1.1	Levels of contaminants, number exceeding regulatory levels	P/I
				9.1.2	Frequency of exceeding regulatory levels	P/I
Descriptor 10: Litter	10.1	Characteristics of litter in the marine and coastal environment	P	10.1.1	Trends in litter on shores	P
				10.1.2	Trends in litter in water column & on sea-floor	P
				10.1.3	Trends in micro-particles	P
	10.2	Impacts of litter on marine life	I	10.2.1	Trends in litter ingested	I
Descriptor 11: Energy, including underwater noise	11.1	Distribution in time and place of loud, low and mid frequency impulsive sounds	P	11.1.1	Anthropogenic sound levels that entail significant impact	P
	11.2	Continuous low frequency sound	P	11.2.1	Ambient noise levels	P

ANNEX VI

End-user involvement in data collection.

In the future data collection system, there should be **four key areas of the data collection process in which end-users of DCF data should be better involved** (see also **Figure 6**):

- i. end-user input (advice) in determining what should or should no longer be collected
- ii. end-user involvement in designing the sampling programme for data collection for those data they will use;
- iii. end-user access to DCF data;
- iv. end-user feedback on the data they have accessed.

Figure 6: Key areas of the data collection process in which end-users of DCF data should be involved

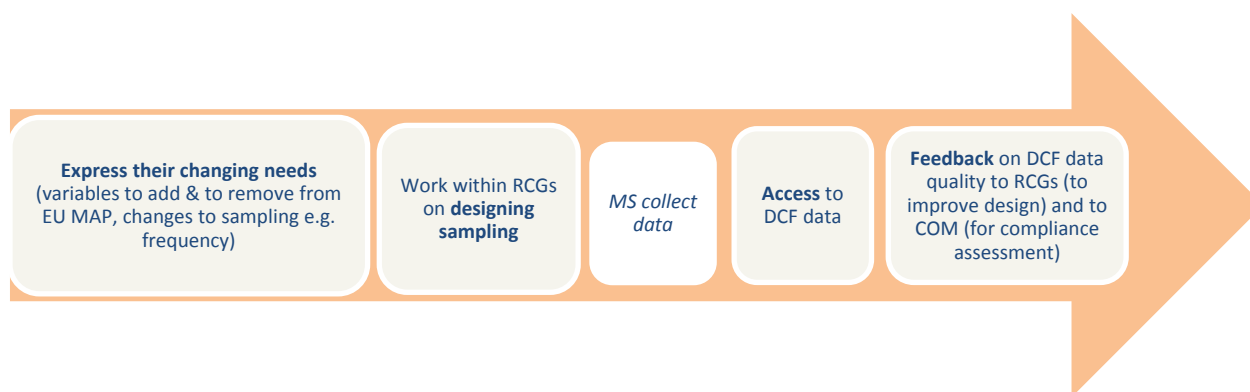

Of the four areas above, the first is detailed below.

i. End-user input (advice) in determining what should or should no longer be collected

Despite the undoubted advantage of involving end-users more in defining the data to be included in the EU MAP, this comes with **risks**. In responding to the need for end-user involvement, the challenge is to find a proper balance between flexibility and continuity. It is also necessary to avoid increasing the cost of data collection as requests from end-users tend to demand more rather than less data.

There is a widespread concern amongst Member States that giving more say to end-users could result in a ratchet effect whereby end-users request ever more data, thereby increasing the costs for Member States. In addition, every time there is a change in the EU MAP, this will require Member States' to amend their work plans.

Therefore, although this could be considered as a faster process, it does not seem appropriate to allow end-user to express their needs directly to Member States regarding what data should be collected (for example in the context of Regional Coordination Groups), and it is preferable to maintain an EU-level filtering or prioritizing process, through adoption of the EU MAP – and its modifications – by the Commission.

On this basis, end-user input regarding what should or should not be collected, would take place in two ways:

1. Regarding **data to be collected under EU MAP**, end-users would be able to express their changing needs to the Commission, along the process presented in **Textbox 4**, which may result in modification of the EU MAP and then of the Member States' work plans.

2. For **additional data** (beyond those collected under the EU MAP), end-users could **express their needs directly to Member States in RCGs**. If these changes are agreed in those fora, then they should be published e.g. on a website, for the sake of transparency, and then Member States would amend their work plans accordingly, without the need for modification of the EU MAP (see **Figure 7**).

As the aim is to increase the responsiveness of the DCF to end-users needs, a clear process should particularly be established to determine **how the EU MAP could be amended**, i.e. who can request new variables to be collected; how these requests should be made, filtered, and prioritized; how a final list of new variables to be collected is decided by the Commission; and when this is inputted into the sampling process for Member States' to produce new sampling plans covering these new needs.

Figure 7: Process to amend data collection requirements under the DCF

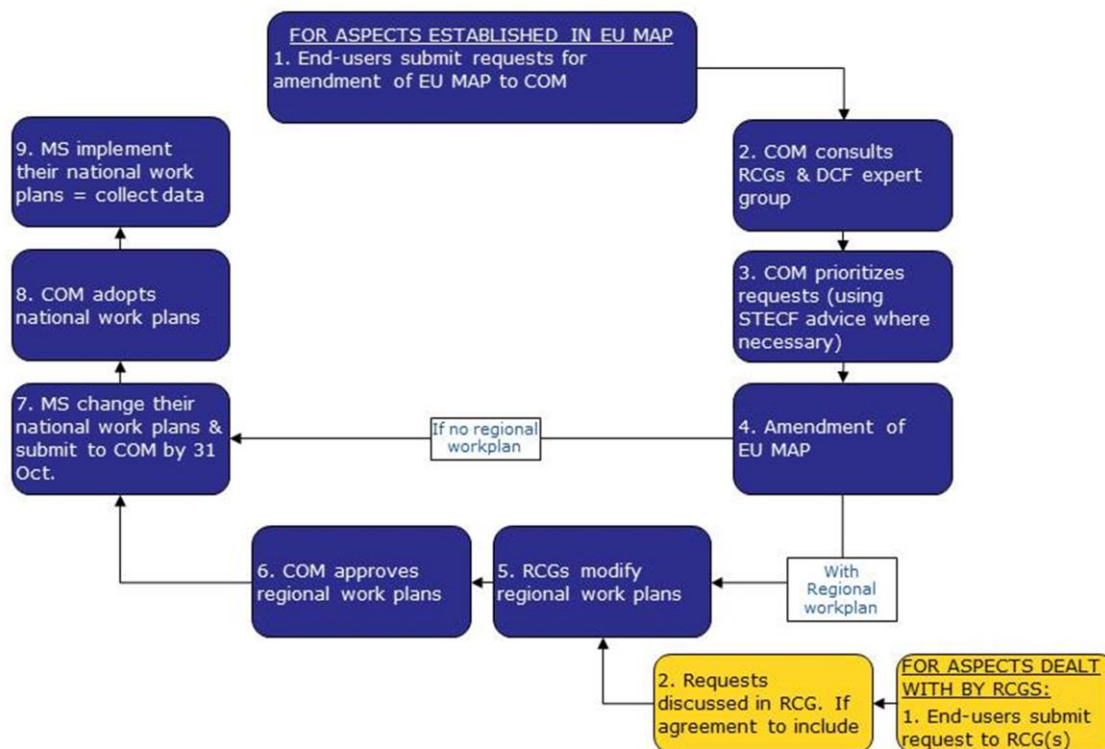

As the current DCF does not include provisions on gathering end-users' input in defining what data should be collected, or in designing sampling programmes, the following changes should be made to the DCF Regulation:

- i) Providing for the **consultation of Regional Coordination Groups (which include relevant end-users) and of the STECF** by the Commission during the preparation and any amendment of the **EU MAP**.
- ii) establishing **criteria** which the Commission would take into account **when deciding whether to include/remove a variable** from the EU MAP. The criteria, based in large part on advice for the STECF¹¹⁰ would be the following:

¹¹⁰ **Member States Experts (11-15 March 2013, Ispra, Italy)** Dedicated STECF EWG meeting 13-02 on the new DC MAP. Report available: [Scientific, Technical and Economic Committee for Fisheries \(STECF\) – Review of the DC MAP – Part 1 \(STECF-13-06\)](#)

- 1) the need and relevance of data for decisions on fisheries management and protection of the ecosystem including vulnerable species,
- 2) the need to support impact assessments of policy measures,
- 3) the needs of the scientific community,
- 4) the resource implications,
- 5) existing time-series,
- 6) the need to avoid duplication of data collection,
- 7) regional specificities,
- 8) and the international obligations of the Union and its Member States.

Details on the legal architecture of the future Data Collection Framework

1. The future DCF Regulation

The future DCF Regulation should maintain the basic provisions that constitute the architecture of the European system of data collection on fisheries, as they have demonstrated their robustness. It would retain key aspects of the current system, including: the establishment of EU multiannual programme; contents of work plans to be implemented by Member States; key obligations upon Member States in relation to collection, storage, protection and provisions of data; provisions on rights of obligations of users of data; and provisions on cooperation within and between Member States, as well as with and between scientific and management bodies.

2. The EU Multiannual Programme

The future DCF Regulation should contain provisions whereby the Commission should adopt, and may modify, through an implementing act, an EU MAP for the collection, management and use of data on the fisheries sector. The EU MAP would contain:

- 1) provisions on the data that should be collected to achieve the objectives of the DCF (biological data, ecosystem data, socio-economic data on fisheries, aquaculture and processing, data on fishing activity of EU fisheries and data on sustainability of aquaculture).
- 2) A list of mandatory research surveys that must be carried out and criteria for selecting these research surveys.
- 3) Thresholds below which Member States do not need to collect data or carry out research surveys.

In practice, compared to the current EU MAP, the future EU MAP would be **lighter**, containing only obligations relating to **what** Member States should collect and make available to data users under the DCF, including list of species and variables and frequency of collection as well as minimum provisions on level of (dis-)aggregation at which data must be made available to ensure harmonization and multiple uses of data. The EU MAP would, however, **no longer contain the current prescriptive provisions** relating to methodology, sampling strategy or guidelines to be followed, or the precision levels to be achieved.

3. Operational Programmes

Member States' Operational Programmes under the EMFF describe the Member States' data collection activities on a multiannual basis. These stem from two sources: EU obligations stemming from the EU MAP (including any international fisheries data collection obligations) and outcomes of agreements in RCGs or the EUCG (see **Figure 5**). Under the future system, National Programmes will be outlined in the section of the Member States' EMFF Operational Programmes (OP), providing the key principles and basic information on the national set-up for implementation of the DCF, as well as a summary of the main activities that will be carried out by the Member States. Such programmes will be less detailed than the current DCF National Programmes and should require less frequent revisions compared to the current set-up.

4. National work plans

National work plans under the EMFF supplement the operational programmes, by providing more detail on, amongst other, the methods that will be followed, on quality assurance, on specific data collection that may take place punctually, or in addition to the obligations stemming from the EU Multiannual programme, including additional data collection agreed in RCGs. Their degree of detail should also be such as not to necessarily require change every year, if appropriate.

5. Regional work plans

As described in section 5.1.2, RCGs may prepare joint recommendations in the form of a regional work plan regarding procedures, methods, quality assurance and quality control for collecting and processing of data as well as a regionally-coordinated sampling strategy in order to achieve an adequate division of tasks among the Member States. The Commission would verify whether the joint recommendations are compatible with the provisions of the DCF Regulation and with the EU MAP and, if so, approve or refuse to approve the regional work plan. Member States should ensure compliance of their national work plans with the applicable regional work plan (if there is one, and it has been approved by the Commission) in the form of a regional work plan. In addition, if adopted by the Commission, such a regional work plan may replace parts of individual national work plans to reduce the administrative burden on Member States. For the sake of transparency, regional work plan should be made publically available, e.g. on a website.

ANNEX VIII

Tasks of Regional Coordination Groups (RCGs)

The RCGs would essentially have four main tasks, relating to regional cooperation (see **Figure 8**):

A. Data to be collected:

i) **Advising the Commission**, when establishing the EU Multiannual Programme and amendments thereof, regarding what data should be collected under the EU Multiannual Programme.

ii) **Agreeing on additional data** (beyond those detailed in the EU MAP) **to be collected at regional level**

B. For all data to be collected (whether detailed in the EU MAP or agreed in RCG), agreeing on **methodological aspects of data collection** such as identifying procedures and methodologies to be followed, agreeing on sampling strategies and agreeing on **sampling levels** (i.e. the latter will no longer be specified in the EU MAP). RCGs would be tasked with methodological aspects relating to biological and ecosystem data. In addition, some data may also be left for RCGs to decide based on the regional specificities, for example which species or fisheries to sample regarding by-catch of protected species.

C. **Planning and coordinating the sampling at regional level**¹¹¹. For e.g. biological data on shared stocks, or on by-catch of protected species, the manner of planning and coordinating sampling at regional level would move to regionally-based sampling as opposed to a previously national approach. Concretely, RCGs would coordinate the preparation of national work plans by establishing regional sampling plans and then allocating shares of sampling to Member States.

Given the resource implications of allocating shares of regional sampling between Member States, it seems advisable to establish '**fallback**' rules for this process, in case Member States cannot reach an agreement on a regional sampling plan. This could be the Member States' share of a TAC, or for non-TAC species, their share of catches (e.g. averaged over the last 2 years). In case no agreement is reached about this in the RCG by a certain deadline, the Commission would act by introducing allocation rules in an implementing act.

D. **Contributing to the quality assurance and quality control** of data. RCGs would be tasked with establishing guidelines for quality assurance and identifying best practices and methodologies that Member States should follow. RCGs will also assess the quality of the **combined biological data** at regional or stock level (or at any other level relevant to the end-users), in order to advise end-users on this, and also to identify improvements that may be necessary in terms of methodologies or best practice.

¹¹¹ Planning and implementing of sampling at a regional level is not relevant for socio-economic data, for which data makes most sense at national level.

Figure 8: Tasks of RCGs

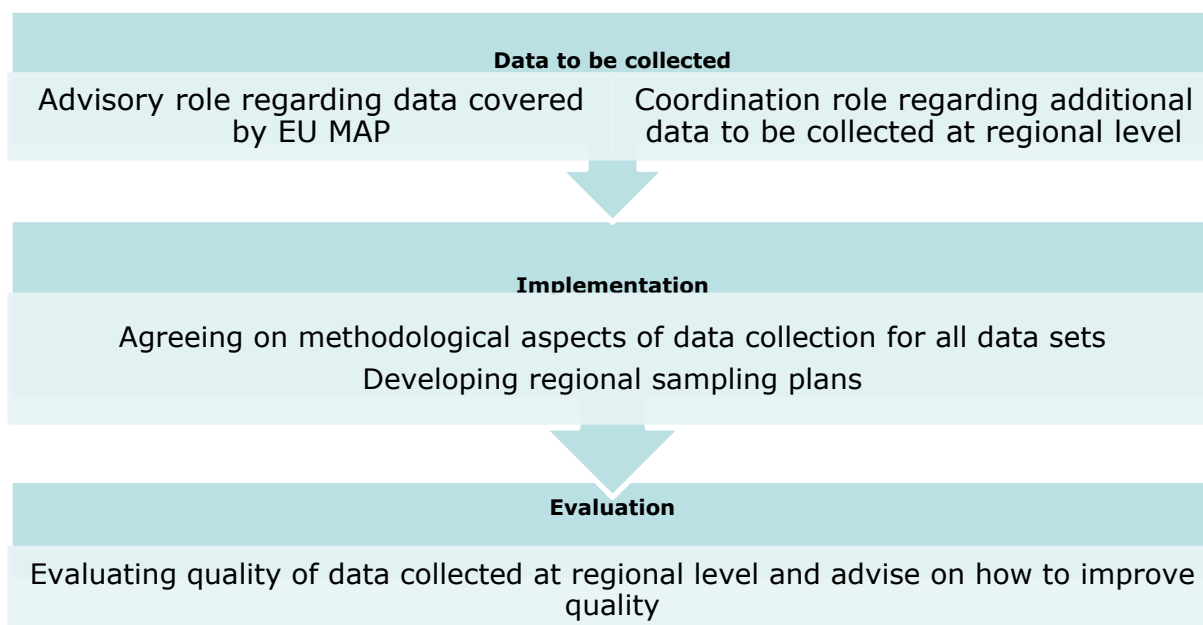

Beyond these tasks, the **DCF would define the membership** of the RCGs and EUCG in general terms. Both RCG and the EUCG membership would consist of Member States experts and the relevant end-users. Third countries sharing fisheries with EU Member States in each marine region could also be invited as observers to RCGs (as is already the case today).

In terms of **governance structure**, one option would be to establish RCGs and the EUCG as legal entities (such as an Advisory Council). This would increase clarity of the obligations or rights of participants, but would be less flexible and would require additional legal acts and delays in establishing such structures. Providing EU funding to such legal entities is not foreseen in the EMFF Regulation. Consultations with Member States revealed that such a formal set up for RCGs or EUCG would go beyond what they desire. The preferred approach is therefore to rather strengthen the current RCM mechanism (established in the DCF with specific tasks), without giving them a legal entity, but extending their tasks as set out above.

As coordination within RCGs and the EUCG increases over time, there is a risk of widening differences, or even divergences, that may result in a reduced homogeneity at EU level. Therefore, provisions to stimulate **coordination between groups** should also be included in the DCF. Namely, coordination between regions should also be ensured, by including a provision in the DCF requiring RCGs to cooperate on issues affecting several regions (e.g. stocks like eels found in several regions) to ensure that data from different regions can be aggregated to stock level to provide meaningful input to data users.

Similarly, past implementation of the DCF shows that there is added- value in closer integration of developments and decision on biological data with those for economic data, for example to facilitate scientific analysis of conservation policies. To ensure this, the DCF should include provisions whereby RCGs, the EUCG and the Commission should coordinate regularly on the work achieved in RCGs and EUCG. To this end, the Commission would organize meetings with chairs of the RCGs and EUCG plus any other relevant stakeholders.

ANNEX IX

Details on data to covered by the current EU MAP regarding commercial fisheries, and possible data collection under the future EU MAP.

A. Regarding commercial fisheries, the following data must be collected according to the **current DCF EU Multiannual Programme**:

- i. For all stocks caught by EU vessels (in EU waters or outside them): **basic data on discards** (volume and length distribution¹¹²).
- ii. For stocks in Appendix VII of the EU Multiannual Programme (over 425): data on quarterly **length distribution of retained catch** are required in addition to 1) above.
- iii. For a sub-set of the stocks in Appendix VII of the EU Multiannual Programme: **biological variables** should be collected in addition to 1) and 2) above. This concerns age (including number of measurements per 1000 t), weight, sex, maturity and fecundity as well as the frequency of collection of these parameters (either every year or every 3 years).

The data included in the current EU MAP consisted essentially of a compilation of needs for individual stocks without an **overall strategy or prioritization** regarding resource allocations. For some stocks, very detailed data requirements were included in the EU MAP and for others much less. The availability of data largely determined the choice of stock assessment (i.e. where more data are available, more robust/precise assessments can be made). This has resulted in a mismatch between the amount and extent of data collected for some stocks and the needs of data users such as fisheries managers, which means that the resources available for data collection may not be used in the most optimal way.

B. Regarding the contents of the future EU MAP for commercial fisheries, a two-step might along the following lines could be envisage:

- i. **A minimum data set** to be collected on all stocks caught by commercial EU fisheries (in EU waters or outside them) to ensure that sufficient information is available to monitor all fisheries, including those which, should they develop, may require greater management measures. The minimum data could consist, for example, of catch composition (i.e. the share of each species in the catches and the length composition per species).
- ii. **Additional specific biological data** (age, sex, maturity, fecundity, weight, stomach content) to be collected for **a sub-set of stocks that are important for policy needs** i.e. those for which the EU or Member States have international obligations or stocks managed or protected by EU legislation.

A new approach to determine what needs to be collected should be followed: The current relationship between data availability and stock assessment should be reversed. There are over 400 stocks covered by the current DCF, and not all require the most robust type of stock assessment and thus will not require the most extensive and frequent data collection. In future, the fisheries managers should prioritize the stocks for which more robust stock assessments

¹¹² Quarterly estimates of length distribution of discards are only required when they represent (on an annual basis), either more than 10 % of the total catches by weight or more than 15 % of the catches in numbers.

are required, and those for which less robust (and less data demanding) assessments are sufficient. On this basis, the data needed to enable the different types of assessment would be included in the EU MAP. This approach would enable a more efficient use of resources for data collection. It is also in line with recommendations made in a European Parliament-commissioned study on Data Deficient Fisheries in the EU¹¹³, as well as with the policies in other important fishing nations such as the United States¹¹⁴ who strive to provide at least baseline monitoring for all managed stocks, full assessments for important stocks, and assessments that extend to ecosystem linkages where needed and feasible.

¹¹³ European Parliament commissioned study (2013) Data-deficient fisheries in EU waters [http://www.europarl.europa.eu/RegData/etudes/etudes/join/2013/495865/IPOL-PECH_ET\(2013\)495865_EN.pdf](http://www.europarl.europa.eu/RegData/etudes/etudes/join/2013/495865/IPOL-PECH_ET(2013)495865_EN.pdf)

¹¹⁴ <http://www.st.nmfs.noaa.gov/stock-assessment/stock-assessment-prioritization>

Additional details on some ecosystem impacts of fisheries

Regarding the **impacts of fisheries on habitats (impact 6 in section 5.2.1.2)**, and in particular on the sea bed: These impacts depend essentially on three factors: the physical and biological characteristics of the sea bed, the type of fishing gear that interacts with the sea bed, and the intensity of this interaction. An EU-led process is underway supported by the European Maritime and Fisheries Fund to deliver open-access seabed mapping of all European waters by 2020. Maps of physical habitats using an agreed classification and building on earlier efforts are already available¹¹⁵ and will be progressively refined. EU-wide projects on seabed mapping have produced maps of the physical characteristics of the seabed for a large part of European waters. Several initiatives to map the biological features and communities are also ongoing¹¹⁶. Data on the distribution of fishing activity, its intensity and the type of gear involved (i.e. the fishing pressure) are already routinely collected under the DCF (through VMS and logbook data and effort data)¹¹⁷. With the knowledge on the seabed composition and of the type of fishing taking place there (e.g. trawling on a coral reef habitat), one can deduce what impact the fishing gear is having in order to take appropriate management decisions (e.g. limiting certain type of gear uses in certain sensitive areas). To further quantify the exact impacts that particular type of fishing operation is having on a particular type of seabed habitat, dedicated research projects are required, such as the BENTHIS project¹¹⁸.

Deep-sea seabed organisms are particularly vulnerable to the impacts of fisheries as they occur in low-energy environments and are therefore slow growing, taking longer to regenerate after an interaction with fishing gear. For this reason, specific monitoring measures have been introduced for these deep-sea organisms. The Northwest Atlantic Fisheries Organization (NAFO), for example, considers certain deep-sea seabed organisms such as corals as indicators of vulnerable marine ecosystems, and fishing vessel encounters with them must be recorded and may lead to management measures being taken (closures of fishing areas)¹¹⁹. The Commission's proposal for a deep sea access regime¹²⁰ also includes specific data collection requirements on sensitive seabed species, for this vulnerable marine ecosystem. Under this proposal, Member States should identify and document the weight of any stony coral, soft coral, sponge or other organism belonging to the same ecosystem taken on board by the vessel's gear.

¹¹⁵ Such as the Mapping European Seabed Habitats project <http://www.searchmesh.net/> that mapped the North-Western European waters, funded by the EU.

¹¹⁶ Such as the Benthic Ecosystem Fisheries Impact Study <http://www.benthis.eu/en/benthis.htm> funded by the EU under the FP7 framework.

¹¹⁷ And the current EU MAP requires Member States to calculate the extent of sea bed area not impacted by fishing gear, as one of the environmental indicators in Appendix XIII.

¹¹⁸ <http://www.benthis.eu/en/benthis.htm>

¹¹⁹ <http://archive.nafo.int/open/fc/2013/fcdoc13-01.pdf>

¹²⁰ **Proposal for a Regulation of the European Parliament and of the Council** establishing specific conditions to fishing for deep-sea stocks in the North-East Atlantic and provisions for fishing in international waters of the North-East Atlantic and repealing Regulation (EC) No 2347/2002. COM(2012) 371 final of 19.7.2012

Regarding proposed changes to the DCF and possible contents of the future EU Multiannual Programme:

Collecting data on **by-catch of non-target species** would contribute to identifying fisheries, areas and seasons with a high incidental by-catch which may not be sustainable for the species involved; to estimate the number of specimens taken in a certain area; and to evaluate mitigation measures.

Collecting data on by-catch of protected species should be feasible since the great majority of these species are not commonly encountered during fisheries trips. Concretely, data on by-catch of protected species could be collected by scientific observers during their routine "fisheries" sampling programmes (of which the primary purpose is monitoring fish). However, ICES has advised that, although useful, this would not be sufficient as fisheries selected to monitor commercial fish are not necessarily the ones that should be sampled to monitor by-catches of e.g. seabirds. Dedicated sampling programmes for non-target species may be required in addition to collecting data via existing fisheries sampling programmes, to ensure the relevant fisheries are covered¹²¹ (see Textbox 5).

Given the differences between sea basins regarding the occurrence of these protected species and their interactions with fisheries, the EU MAP would specify that RCGs, in consultation with end-users, are to specify the species, the variables and the way in which the sampling should be carried out, as recommended also by STECF¹²². The species and variables selected by RCGs would be published e.g. on a website, for the sake of clarity and transparency.

Textbox 5 - Resource implications for collection of data on incidental catches of protected species

Collecting data on by-catches by commercial fisheries of protected species as part of routine "fisheries" sampling programmes that already exist under the DCF does not require sending additional scientific observers to carry out research surveys at sea, but rather involves training the "fisheries" observers and equipping them with identification manuals or other tools so that they can identify the protected species when it is encountered.

This will require additional staff time on board for some of this identification work, as well as time to process and analyse these additional data. Time for training the observers or compiling/developing identification tools will also be required. Estimating that annually 3 days will be necessary for training, plus 10 days for data analysis and processing and identification work, and using the individual Member States' average staff rates for scientists and technicians¹²³, this results in annual costs of between 400 € and 6200 € per Member State, and around 60 000 € at EU-level.

If additional dedicated sampling is carried out, based on RCG recommendations, additional costs will be required to cover the staff time of an observer at sea as well as for data management. Taking as example 20 days per Member State for collection of these data at sea and for data management, this would result in an additional cost of between 600 € and 8000 € per Member State, and around 70 000 € at EU-level.

80% of these costs can be covered by EU co-financing under the EMFF.

Furthermore, the EU MAP should require Member States to sample all their catches, whether these are targeted or not, retained on board or not, of commercial species or not.

Regarding **impacts on foodwebs**, stomach content data are collected through research surveys at sea and require dedicated time on board to collect specimens, as well as in the laboratory to analyse the stomach content and model the food webs and population dynamics

¹²¹ ICES (2013). ICES Advice on the Special Request from the EU concerning monitoring of bycatch of cetaceans and other protected species. ICES Advice April 2013, Book 1, section 1.5.1, 4 pp.

¹²² http://stecf.jrc.ec.europa.eu/c/document_library/get_file?uuid=8b0acc5-cad9-4f11-85a2-5c315f4b068e&groupId=43805

¹²³ Based on average staff costs in the EU Member States' financial forms for their 2011 data collection programmes

(see **Error! Reference source not found.**). Such data are essential to understand the effect of predator-prey interactions, which is at the core of **multispecies management advice**. It can also contribute to understanding the impacts of fisheries on seabed communities¹²⁴. Collecting stomachs on board research vessels is already done routinely by some Member States, but for others, it would come as an addition to the current work occurring on research cruises.

The DCF Regulation would include a provision requiring Member States to collect data on impacts of fisheries on food webs, to enable ecosystem-based fisheries management. The EU MAP would specify the species for which stomach content data should be collected, to enable such as assessment of fisheries impacts on food webs. These species will be those for which the fisheries managers would like to carry out ecosystem-based management. Because this decision lies with the fisheries managers, it is more appropriate to include the species list in the EU MAP than to let RCG decide on the species for which stomach content data collection should be carried out. However, given the potential for task sharing and resource efficiency in developing stomach content sampling programmes, the EU MAP would specify that RCGs should develop regional sampling plans including the methodologies that should be followed.

Textbox 6 - Resource implications for collection of data on foodwebs

During research surveys at sea, scientists collect stomachs on board, then either analyse their contents during the research cruise, and/or preserve the stomachs and analyse their contents back in the laboratory. Analysing the species contained in a stomach in formalin or alcohol is a lengthy process. In order to have a general overview of the trophic status of the system and interactions, the data then need to be analysed and incorporated into foodweb models.

A more generalised approach to collecting stomach content data may require additional staff on board the research vessel to carry out the tasks of stomach collection and analysis. Additional staff time will also be required for analysis of the stomach contents in the lab and for the data analysis and modelling. Using the individual Member States' average staff rates for scientists and technicians¹²⁵, and presuming that annually all Member States would require: i) 2 additional staff for 10 days of research survey at sea, ii) 120 days for stomach content analysis in the lab, iii) 110 days for analysis and modelling, , annual additional costs would amount between 9000 € and 110 000 € per Member State, and around 1 100 000 € at EU level.

80% of these costs can be covered by EU co-financing under the EMFF.

Regarding the **impact of fisheries on habitats**, in addition to the data on the **pressure of fishing activity** on seabed habitats, which can be derived from fishing activity data already collected under the current DCF, additional quantitative data on the specific impacts should be collected. The DCF Regulation would contain requirements for Member States to collect data on impacts of fishing gears on marine habitats to enable assessment of the effect of fisheries on the marine ecosystem. The EU MAP would contain provisions regarding the exact seabed organisms on which data should be collected, and these would at a minimum reflect the current obligations under international law (e.g. NAFO) or EU law (e.g. the deep-sea access regime Regulation once it is adopted).

Finally, the EU MAP should no longer contain a list of environmental indicators, as is currently the case, because on the one hand these are now out of date in light of MSFD

¹²⁴ For example, see <http://oceanbites.org/bottom-trawling-changes-bodies-the-new-seafloor-diet/comment-page-1/#comment-83850>

¹²⁵ Based on average staff costs in the EU Member States' financial forms for their 2011 data collection programmes

developments, and on the other hand, a regulation on data collection and provision is not the appropriate instrument to include indicators, which constitute a use of the data.

Beyond the changes in the legal framework, the Commission will encourage Member States to make better use of existing, or modified research surveys to ensure the most cost-effective data collection for both fisheries and environmental purposes. Possibilities for integration of DCF monitoring with monitoring for other MSFD descriptors have been investigated and reported in the Technical guidance on monitoring for the Marine Strategy Framework Directive Work¹²⁶.

¹²⁶ JRC Scientific and Policy reports (2014). Technical guidance on monitoring for the Marine Strategy Framework Directive (section 5.3.4) <http://publications.jrc.ec.europa.eu/repository/bitstream/JRC88073/lb-na-26499-en-n.pdf.pdf>

ANNEX XI

Overview of the main differences between the data on aquaculture covered by the DCF and the statistical legislation on aquaculture

All EU Member States collect data on the **volume and value of primary production** (first sale for human consumption) by aquaculture production unit on their whole aquaculture sector (including freshwater) for the purpose of compliance with European **statistical** regulation on aquaculture¹²⁷. Similar data are collected (and collated by JRC) under the DCF, but based on **turnover** (difference with production because fish may be sold several times during their lifetime), by companies (with a threshold) on a different reporting time (January instead of November, calendar year versus accounting year), also on companies producing juveniles (nurseries, hatcheries, ornamental fish), with a different segmentation (by species instead of groups) and with different rules on confidentiality (<10 companies vs <3). Most variables can easily be adjusted, the main problem are the variables (production or turnover), and the level (company or unit).

Under the DCF also **economic and social data** on costs, profits and employment are collected using different methods depending on the Member States, and also on the type of data. Companies systematically record most of the required data in their accounts, and some of these data are routinely collected through national statistical offices for national purposes and/or for the purpose of compliance with European statistical regulation on aquaculture. Some Member States' reuse the economic data obtained via their statistical office for DCF end-users (such as the STECF), whilst in other Member States, the bodies involved in the DCF programme collect the data directly from companies e.g. via questionnaires or phone surveys or personal visits.

¹²⁷ **Regulation (EC) 762/2008 of the European Parliament and of the Council** of 9 July 2008, on the submission by Member States of statistics on aquaculture and repealing Council Regulation (EC) 788/96 (Text with EEA relevance)